

# Dynamic output feedback compensation for linear systems with independent amplitude and rate saturations

FENG TYAN† and DENNIS S. BERNSTEIN‡

The positive real lemma provides the basis for constructing linear output feedback dynamic compensators for multi-input plants with independent amplitude saturations. Fixed-structure techniques are used to obtain full- and reduced-order feedback compensators along with a guaranteed domain of attraction. These results are then applied to the problem of rate saturation. By using a feedback-type model, rate saturation is modelled as an amplitude saturation. The closed-loop system with amplitude and rate saturation is then treated as a system with independent 'amplitude' saturations.

## Nomenclature

- $I_r$   $r \times r$  identity matrix
- $S^n, N^n, P^n$   $n \times n$  symmetric, non-negative-definite, positive-definite matrices
- $\lambda_{\max}(F), \lambda_{\min}(F)$  maximum and minimum eigenvalues of matrix  $F$  having real eigenvalues
- $\|x\|$  euclidian norm of  $x$ , i.e.  $\|x\| = (x^T x)^{1/2}$
- Re real part
- $(\cdot)^*$  complex conjugate transpose
- diag( $d_1, \dots, d_r$ ) diagonal matrix with listed diagonal elements

## 1. Introduction

The need for controlling dynamic systems subject to input saturation is a widespread problem of immense practical importance in control engineering. Most of the literature on this subject addresses constraints on the amplitude of the control input (Campo and Morari 1990, Frankena and Sivan 1979, Fuller 1969, Gutman and Hagander 1985, Horowitz 1983, Klai *et al.* 1993, Kosut 1983, LeMay 1964, Lin and Saberi 1993, Lin *et al.* 1995, Lindner *et al.* 1991, Ryan 1982, Shrivastava and Stengel 1989, Sontag 1984, Teel 1995, Wredenhagen and Belanger 1994). These papers employ a wide variety of techniques. For example, the circle criterion was used in Kosut (1983); a Riccati equation approach was adopted in Lin and Saberi (1993); an anti-windup technique was applied in Campo and Morari (1990); and an LQR-type controller was constructed in Wredenhagen (1994). However, none of these papers

---

Received 1 June 1995. Revised 7 November 1996.

† Department of Aerospace Engineering, TamKang University, Tamsui, Taipei County, Taiwan 25137. e-mail: tyanfeng@hornet.aero.tku.edu.tw.

‡ Department of Aerospace Engineering, The University of Michigan, Ann Arbor, MI 48109-2118, U.S.A. Tel: + 1 (313) 764 3719; Fax: + 1 (313) 763 0578; e-mail: dsbaero@umich.edu.

provides a direct connection between the performance index and the domain of attraction. Finally, several studies consider rate constraints on the control input (see for example Feng *et al.* 1992, Hanson and Stengel 1984, Horowitz 1984, Kapasouris and Athans 1990, and Zhang and Evans 1988).

In the present paper we begin by considering systems having independent input amplitude saturations. Positive-real-type absolute stability analysis is applied to provide a guaranteed domain of attraction, while optimization techniques are used to synthesize feedback controllers that provide acceptable performance. Our approach is based upon LQG-type fixed-structure techniques which characterize both full- and reduced-order linear controllers. A similar technique was applied to the control saturation problem in Tyan and Bernstein (1995a, 1995b) for a radial-type amplitude saturation, where the direction of control input is preserved by the saturation nonlinearity. A key aspect of the approach of the present paper, as well as of Tyan and Bernstein (1995a, 1995b), is the guaranteed subset of the domain of attraction of the closed-loop system. In Lin and Saberi (1993) and Teel (1995), local or global stability is based upon *a priori* assumptions that the initial conditions and states of the system lie in a predefined compact set and, in turn, the control input lies in a bounded region. However, our approach does not require such assumptions. In fact, our main result, Theorem 2.1, assumes instead that the initial condition lies in a prescribed region which is a subset of the domain of attraction. The resulting control signal is thus free to saturate during closed-loop operation without loss of stability. The specified subset of the domain of attraction thus provides a guaranteed region of attraction, which is not provided by qualitative local results.

To model rate saturation, we adopt a position-feedback-type system with a saturation nonlinearity inside the loop as in Feng *et al.* (1992), Kapasouris and Athans (1990) and Zhang and Evans (1988). In these studies, only unity gain is used before the saturation nonlinearity, and thus the rate saturation model may be inaccurate when the control input has high frequency components. To remedy this, the unity gain is now replaced by a larger gain, which is shown to yield improved results.

With this rate saturation model, the closed-loop system with amplitude and rate saturation can be treated as a system with 'amplitude' saturations only. We then generalize the independent amplitude saturation methodology to characterize optimal linear dynamic compensators. This generalization is required by the feedback loop of the rate saturation model, which yields a closed-loop system involving a feedthrough term, which does not appear in the amplitude saturation problem.

The contents of the paper are as follows. In § 2 we present the first main result (Theorem 2.1) which guarantees stability with a specified domain of attraction for a system with independent amplitude saturations. In § 3 fixed-order optimization is applied to Theorem 2.1 to construct full- and reduced-order dynamic compensators along with optimal performance and a guaranteed domain of attraction. In § 4 we adopt a rate saturation model and give a corresponding closed-loop system realization of a system with independent amplitude and rate saturation. This section also contains the second main theorem (Theorem 4.1), which is based upon the amplitude and rate saturation model used in the previous section. In § 5 the fixed-structure optimization technique, based on Theorem 4.1, is again used to derive full- and reduced-order dynamic compensators. Finally, Propositions 3.1 and 5.1 are applied in § 6 to an example given in Rodriguez and Cloutier (1994).

## 2. Analysis of systems with independent amplitude saturation nonlinearities

In this section we consider the closed-loop system

$$\dot{\tilde{x}}(t) = \tilde{A}\tilde{x}(t) + \tilde{B}(\sigma(u(t)) - u(t)), \quad \tilde{x}(0) = \tilde{x}_0 \quad (2.1)$$

$$u(t) = \tilde{C}\tilde{x}(t) \quad (2.2)$$

where  $\tilde{x} \in \mathbf{R}^{\tilde{n}}$ ,  $u \in \mathbf{R}^m$ ,  $\tilde{A}, \tilde{B}, \tilde{C}$  are real matrices of compatible dimension, and  $\sigma: \mathbf{R}^m \rightarrow \mathbf{R}^m$  is a multivariable saturation nonlinearity. We assume that  $\sigma(\cdot)$  is an independent symmetric saturation function, that is,  $\sigma(u) \triangleq [\sigma_1(u_1) \cdots \sigma_m(u_m)]^T$ , where, for each saturation level  $\bar{u}_i > 0$ ,

$$\sigma_i(u_i) \triangleq \text{sat}_{\bar{u}_i}(u_i), \quad i = 1, \dots, m \quad (2.3)$$

where

$$\begin{aligned} \text{sat}_{\bar{u}_i}(u_i) &= u_i, & |u_i| &\leq \bar{u}_i \\ &= \text{sgn}(u_i)\bar{u}_i, & |u_i| &> \bar{u}_i \end{aligned}$$

For  $m \geq 2$  the saturation function  $\sigma(\cdot)$  may change the direction of control input, that is,  $\sigma(u(t))$  is not necessarily in the same direction as  $u$  is (see Fig. 1). Equivalently,  $\sigma(u)$  can be written as

$$\sigma(u) = \beta(u)u \quad (2.4)$$

where  $\beta(u) \triangleq \text{diag}(\beta_1(u_1), \dots, \beta_m(u_m))$ , and the function  $\beta_i: \mathbf{R} \rightarrow (0, 1]$ ,  $i = 1, \dots, m$ , is defined by

$$\left. \begin{aligned} \beta_i(u_i) &= 1, & |u_i| &\leq \bar{u}_i \\ &= \frac{\bar{u}_i}{|u_i|}, & |u_i| &> \bar{u}_i \end{aligned} \right\} \quad (2.5)$$

The closed-loop system (2.1), (2.2) can be represented by the block diagram shown in Fig. 2.

The following result provides the foundation for our synthesis approach. For convenience, we define

$$R_0 \triangleq \text{diag}(R_{01}, \dots, R_{0m}), \quad \beta_0 \triangleq \text{diag}(\beta_{01}, \dots, \beta_{0m})$$

**Theorem 2.1:** *Let  $\tilde{R}_1 \in \mathbf{N}^{\tilde{n}}$ ,  $R_2 \in \mathbf{P}^m$ ,  $\beta_{0i} \in [0, 1]$ ,  $i = 1, \dots, m$ , and assume that  $(\tilde{A}, \tilde{C})$  is observable. Furthermore, suppose there exists  $\tilde{P} \in \mathbf{P}^{\tilde{n}}$  satisfying*

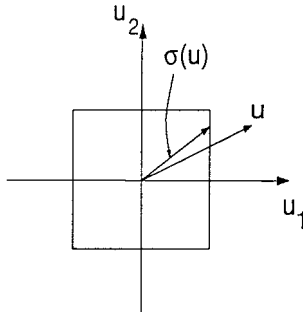

Figure 1. Independent amplitude saturation nonlinearity.

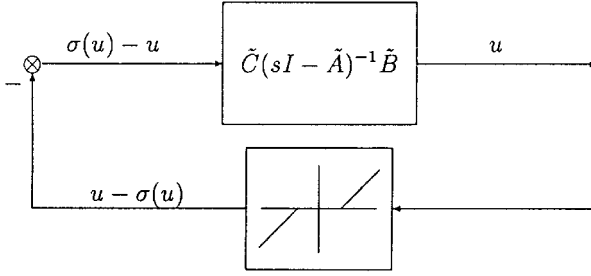

Figure 2. Closed-loop system with a deadzone nonlinearity in negative feedback.

$$0 = \tilde{A}^T \tilde{P} + \tilde{P} \tilde{A} + \tilde{R}_1 + \tilde{C}^T R_2 \tilde{C} + \frac{1}{2} [\tilde{B}^T \tilde{P} - R_0 (I - \beta_0) \tilde{C}]^T R_0^{-1} [\tilde{B}^T \tilde{P} - R_0 (I - \beta_0) \tilde{C}] \quad (2.6)$$

Then the closed-loop system (2.1), (2.2) is asymptotically stable with Lyapunov function  $V(\tilde{x}) = \tilde{x}^T \tilde{P} \tilde{x}$ , and the set

$$\tilde{\mathcal{D}} \triangleq \{\tilde{x}_0 \in \mathbf{R}^{\tilde{n}} : V(\tilde{x}_0) < V_0\} \quad (2.7)$$

is a subset of the domain of attraction of the closed-loop system, where

$$V_0 \triangleq \min \{\bar{u}_i^2 / (\beta_i^2 \tilde{C}_i \tilde{P}^{-1} \tilde{C}_i^T) : i = 1, \dots, m\} \quad (2.8)$$

$\tilde{C}_i$  is the  $i$ th row of  $\tilde{C}$ ,  $i = 1, \dots, m$ , and

$$\beta_i \triangleq \max \left\{ 0, \frac{1}{2} \left[ 1 + \beta_{0\max} - \sqrt{(1 - \beta_{0\max})^2 + 2\lambda_{\min}(R_2 R_0^{-1})} \right] \right\}$$

$$\beta_{0\max} \triangleq \max \{\beta_{0i} : i = 1, \dots, m\}$$

**Proof:** The procedure of the proof is similar to that providing absolute stability, see for example, Haddad and Bernstein (1991). For details, see the Appendix.  $\square$

**Remark 2.1:** As in Tyan and Bernstein (1995a) Theorem 2.1 can be viewed as an application of the positive real lemma of Anderson (1967) to a deadzone nonlinearity. To see this, define

$$\tilde{L}^T \triangleq [-(\tilde{B}^T \tilde{P} - R_0 (I - \beta_0))^T \tilde{C} (2R_0)^{-1/2} \quad (\tilde{R}_1 + \tilde{C}^T R_2 \tilde{C})^{1/2}] V, \quad \tilde{W}^T \triangleq [(2R_0)^{1/2} \quad 0] V$$

where  $V^T V = I$ . It is easy to check that the equations

$$0 = \tilde{A}^T \tilde{P} + \tilde{P} \tilde{A} + \tilde{L}^T \tilde{L}$$

$$0 = \tilde{P} \tilde{B} - \tilde{C}^T (I - \beta_0) R_0 + \tilde{L}^T \tilde{W}$$

$$0 = 2R_0 - \tilde{W}^T \tilde{W}$$

are satisfied and are equivalent to the Riccati equation (2.6). It thus follows that  $\tilde{G}(s)$  is positive real, where

$$\tilde{G}(s) \sim \left[ \frac{\tilde{A}}{R_0 (I - \beta_0) \tilde{C}} \mid \frac{\tilde{B}}{R_0} \right] \quad \square$$

**Remark 2.2:** The small gain theorem can be viewed as a special case of the application of Theorem 2.1. This can be verified by using a simple loop shifting

technique. First, note that the closed-loop (2.1), (2.2) can be written as

$$\dot{\tilde{x}}(t) = (\tilde{A} - \frac{1}{2}\tilde{B}\tilde{C})\tilde{x}(t) + \tilde{B}(\sigma(u(t)) - \frac{1}{2}u(t)), \quad \tilde{x}(0) = \tilde{x}_0 \quad (2.9)$$

$$u(t) = \tilde{C}\tilde{x}(t) \quad (2.10)$$

and it is easy to check that the nonlinearity  $\sigma(u(t)) - \frac{1}{2}u(t)$  is bounded by the sector  $[-\frac{1}{2}I, \frac{1}{2}I]$ . Next, by choosing  $\beta_0 = 0$ ,  $R_0 = 2I$ ,  $\tilde{R}_1 = 0$ ,  $R_2 = 0$ , equation (2.6) can be reduced to the Riccati equation

$$0 = (\tilde{A} - \frac{1}{2}\tilde{B}\tilde{C})^T \tilde{P} + \tilde{P}(\tilde{A} - \frac{1}{2}\tilde{B}\tilde{C}) + \tilde{C}^T \tilde{C} + \frac{1}{4}\tilde{P}\tilde{B}\tilde{B}^T \tilde{P} \quad (2.11)$$

which implies that

$$\left\| \left[ \begin{array}{c|c} \tilde{A} - \frac{1}{2}\tilde{B}\tilde{C} & \tilde{B} \\ \hline \tilde{C} & 0 \end{array} \right] \right\|_{\infty} \leq 2 \quad (2.12)$$

□

### 3. Linear controller synthesis for systems with independent amplitude saturation

In this section, we consider linear controller synthesis based upon Theorem 2.1. Consider the plant  $G(s)$  with the realization

$$\dot{x}(t) = Ax(t) + B\sigma(u(t)), \quad x(0) = x_0 \quad (3.1)$$

$$y(t) = Cx(t) \quad (3.2)$$

where  $x \in \mathbf{R}^n$ ,  $u \in \mathbf{R}^l$ ,  $y \in \mathbf{R}^l$ ,  $(A, B)$  is controllable,  $(A, C)$  is observable, and let the dynamic compensator  $G_c(s)$  have the form

$$\dot{x}_c(t) = A_c x_c(t) + B_c y(t), \quad x_c(0) = x_{c0} \quad (3.3)$$

$$u(t) = C_c x_c(t) \quad (3.4)$$

where  $x_c \in \mathbf{R}^{n_c}$  and  $n_c \leq n$ . Then the closed-loop system can be written in the form of (2.1), (2.2) with

$$\tilde{x} \triangleq \begin{bmatrix} x \\ x_c \end{bmatrix}, \quad \tilde{x}_0 \triangleq \begin{bmatrix} x_0 \\ x_{c0} \end{bmatrix}, \quad \tilde{A} \triangleq \begin{bmatrix} A & BC_c \\ B_c C & A_c \end{bmatrix}, \quad \tilde{B} \triangleq \begin{bmatrix} B \\ 0 \end{bmatrix}, \quad \tilde{C} \triangleq [0 \quad C_c]$$

Our goal is to determine gains  $A_c, B_c, C_c$  that minimize the LQG-type cost

$$J(A_c, B_c, C_c) = \text{tr } \tilde{P}\tilde{V} \quad (3.5)$$

where

$$\tilde{V} = \begin{bmatrix} V_1 & 0 \\ 0 & B_c V_2 B_c^T \end{bmatrix}$$

$\tilde{P}$  satisfies (2.6), and  $V_1 \in \mathbf{N}^n$  and  $V_2 \in \mathbf{P}^l$  are analogous to the plant disturbance and measurement noise intensity matrices of LQG theory, respectively. Furthermore, let

$$\tilde{R}_1 = \begin{bmatrix} R_1 & 0 \\ 0 & 0 \end{bmatrix}$$

where  $R_1 \in \mathbf{N}^n$ .

We first consider the full-order controller case, that is,  $n_c = n$ . The following results are obtained by minimizing  $J(A_c, B_c, C_c)$  with respect to  $A_c, B_c, C_c$ . These necessary conditions then provide sufficient conditions for closed-loop stability by

applying Theorem 2.1. For convenience define

$$\begin{aligned}\Sigma &\triangleq \frac{1}{4}B(I + \beta_0)[R_2 + \frac{1}{2}(I - \beta_0)R_0(I - \beta_0)]^{-1}(I + \beta_0)B^T, \quad \Sigma_0 \triangleq \frac{1}{2}BR_0^{-1}B^T, \\ \bar{\Sigma} &\triangleq C^T V_2^{-1}C\end{aligned}$$

**Proposition 3.1:** *Let  $n_c = n$ , suppose there exist  $n \times n$  non-negative-definite matrices  $P, Q, \hat{P}$  satisfying*

$$0 = A^T P + PA + R_1 - P(\Sigma - \Sigma_0)P \quad (3.6)$$

$$0 = (A - Q\bar{\Sigma} + \Sigma_0 P)^T \hat{P} + \hat{P}(A - Q\bar{\Sigma} + \Sigma_0 P) + \hat{P}\Sigma_0 \hat{P} + P\Sigma P \quad (3.7)$$

$$0 = [A + \Sigma_0(P + \hat{P})]Q + Q[A + \Sigma_0(P + \hat{P})]^T + V_1 - Q\bar{\Sigma}Q \quad (3.8)$$

and let  $A_c, B_c, C_c$  be given by

$$A_c = A + \frac{1}{2}B(I + \beta_0)C_c - B_c C + \Sigma_0 P \quad (3.9)$$

$$B_c = QC^T V_2^{-1} \quad (3.10)$$

$$C_c = -\frac{1}{2}[R_2 + \frac{1}{2}(I - \beta_0)R_0(I - \beta_0)]^{-1}(I + \beta_0)B^T P \quad (3.11)$$

Furthermore, suppose that  $(\tilde{A}, \tilde{C})$  is observable. Then

$$\tilde{P} = \begin{bmatrix} P + \hat{P} & -\hat{P} \\ -\hat{P} & \hat{P} \end{bmatrix}$$

satisfies (2.6), and  $(A_c, B_c, C_c)$  is an extremal of  $J(A_c, B_c, C_c)$ . Furthermore, the closed-loop system (2.1), (2.2) is asymptotically stable, and  $\mathcal{D}$  defined by (2.7) is a subset of the domain of attraction of the closed-loop system.

**Proof:** The proof is a special case of the proof of Proposition 3.2 below with  $n_c = n$  and  $\Gamma = G^T = \tau = I$ .  $\square$

Next we consider the reduced-order case  $n_c \leq n$ . The following lemma is required.

**Lemma 3.1** (Bernstein and Haddad 1989): *Let  $\hat{P}, \hat{Q}$  be  $n \times n$  non-negative-definite matrices and suppose that  $\text{rank } \hat{Q}\hat{P} = n_c$ . Then there exist  $n_c \times n$  matrices  $G, \Gamma$  and an  $n_c \times n_c$  invertible matrix  $M$ , unique except for a change of basis in  $\mathbf{R}^{n_c}$ , such that*

$$\hat{Q}\hat{P} = G^T M \Gamma, \quad \Gamma G^T = I_{n_c} \quad (3.12)$$

Furthermore, the  $n \times n$  matrices

$$\tau \triangleq G^T \Gamma, \quad \tau_{\perp} \triangleq I_n - \tau \quad (3.13)$$

are idempotent and have  $\text{rank } n_c$  and  $n - n_c$ , respectively. If, in addition,  $\text{rank } \hat{Q} = \text{rank } \hat{P} = n_c$ , then

$$\tau \hat{Q} = \hat{Q}, \quad \hat{P} \tau = \hat{P} \quad (3.14)$$

**Proposition 3.2:** *Let  $n_c \leq n$ , suppose there exist  $n \times n$  non-negative-definite matrices  $P, Q, \hat{P}, \hat{Q}$  satisfying*

$$0 = A^T P + PA + R_1 - P(\Sigma - \Sigma_0)P + \tau_{\perp}^T P \Sigma P \tau_{\perp} \quad (3.15)$$

$$0 = (A - Q\bar{\Sigma} + \Sigma_0 P)^T \hat{P} + \hat{P}(A - Q\bar{\Sigma} + \Sigma_0 P) + \hat{P}\Sigma_0 \hat{P} + P\Sigma P - \tau_{\perp}^T P \Sigma P \tau_{\perp} \quad (3.16)$$

$$0 = [A + \Sigma_0(P + \hat{P})]Q + Q[A + \Sigma_0(P + \hat{P})]^T + V_1 - Q\bar{\Sigma}Q + \tau_{\perp} Q\bar{\Sigma}Q \tau_{\perp}^T \quad (3.17)$$

$$0 = [A - (\Sigma - \Sigma_0)P]\hat{Q} + \hat{Q}[A - (\Sigma - \Sigma_0)P]^T + Q\bar{\Sigma}Q - \tau_{\perp} Q\bar{\Sigma}Q \tau_{\perp}^T \quad (3.18)$$

$$\text{rank } \hat{Q} = \text{rank } \hat{P} = \text{rank } \hat{Q}\hat{P} = n_c \quad (3.19)$$

and let  $A_c, B_c, C_c$  be given by

$$A_c = \Gamma A G^T + \frac{1}{2} \Gamma B(I + \beta_0)C_c - B_c C G^T + \Gamma \Sigma_0 P G^T \quad (3.20)$$

$$B_c = \Gamma Q C^T V_2^{-1} \quad (3.21)$$

$$C_c = -\frac{1}{2} [R_2 + \frac{1}{2}(I - \beta_0)R_0(I - \beta_0)]^{-1} (I + \beta_0) B^T P G^T \quad (3.22)$$

Furthermore, suppose that  $(\tilde{A}, \tilde{C})$  is observable. Then

$$\tilde{P} = \begin{bmatrix} P + \hat{P} & -\hat{P}G^T \\ -G\hat{P} & G\hat{P}G^T \end{bmatrix}$$

satisfies (2.6), and  $(A_c, B_c, C_c)$  is an extremal of  $J(A_c, B_c, C_c)$ . Furthermore, the closed-loop system (2.1), (2.2) is asymptotically stable, and  $\mathcal{D}$  defined by (2.7) is a subset of the domain of attraction of the closed-loop system.

**Proof:** The result is obtained by applying the Lagrange multiplier technique to (3.5) subject to (2.6) and by partitioning  $\tilde{P}$  and  $\tilde{Q}$  as

$$\tilde{P} = \begin{bmatrix} P_1 & P_{12} \\ P_{12}^T & P_2 \end{bmatrix}, \quad \tilde{Q} = \begin{bmatrix} Q_1 & Q_{12} \\ Q_{12}^T & Q_2 \end{bmatrix}$$

Here, we show only the key steps. First, define the lagrangian

$$\begin{aligned} \mathcal{L} = & \text{tr } \tilde{P}\tilde{V} + \text{tr } \tilde{Q}[(\tilde{A} - \frac{1}{2}\tilde{B}(I - \beta_0)\tilde{C})^T \tilde{P} + \tilde{P}(\tilde{A} - \frac{1}{2}\tilde{B}(I - \beta_0)\tilde{C}) + \tilde{R}_1 \\ & + \tilde{C}^T(R_2 + \frac{1}{2}(I - \beta_0)R_0(I - \beta_0))\tilde{C} + \frac{1}{2}\tilde{B}\tilde{R}_0^{-1}\tilde{B}^T\tilde{P}] \end{aligned}$$

Taking derivatives with respect to  $A_c, B_c, C_c$  and  $\tilde{P}$ , and setting them to zero yields

$$0 = \frac{\partial \mathcal{L}}{\partial A_c} = 2(P_{12}^T Q_{12} + P_2 Q_2) \quad (3.23)$$

$$0 = \frac{\partial \mathcal{L}}{\partial B_c} = 2P_2 B_c V_2 + 2(P_{12}^T Q_1 + P_2 Q_{12}^T) C^T \quad (3.24)$$

$$0 = \frac{\partial \mathcal{L}}{\partial C_c} = 2[R_2 + \frac{1}{2}(I - \beta_0)R_0(I - \beta_0)] C_c Q_2 + (I + \beta_0) B^T (P_1 Q_{12} + P_{12} Q_2) \quad (3.25)$$

$$\begin{aligned} 0 = \frac{\partial \mathcal{L}}{\partial \tilde{P}} = & [\tilde{A} - \frac{1}{2}\tilde{B}(I - \beta_0)\tilde{C} + \frac{1}{2}\tilde{B}\tilde{R}_0^{-1}\tilde{B}^T\tilde{P}]\tilde{Q} \\ & + \tilde{Q}[\tilde{A} - \frac{1}{2}\tilde{B}(I - \beta_0)\tilde{C} + \frac{1}{2}\tilde{B}\tilde{R}_0^{-1}\tilde{B}^T\tilde{P}]^T + \tilde{V} \end{aligned} \quad (3.26)$$

Next, define  $P, Q, \hat{P}, \hat{Q}, \Gamma, G, M$  by

$$\begin{aligned} P \triangleq & P_1 - \hat{P}, \quad \hat{P} \triangleq P_{12} P_2^{-1} P_{12}^T, \quad Q \triangleq Q_1 - \hat{Q}, \quad \hat{Q} \triangleq Q_{12} Q_2^{-1} Q_{12}^T \\ G^T \triangleq & Q_{12} Q_2^{-1}, \quad M \triangleq Q_2 P_2, \quad \Gamma \triangleq -P_2^{-1} P_{12}^T \end{aligned}$$

Algebraic manipulation of equations (3.24) and (3.25) yields  $B_c$  and  $C_c$  given by (3.21) and (3.22). The expression (3.20) for  $A_c$  is obtained by combining the (1,2) and (2,2) blocks of equation (2.6) or (3.26) using (3.23). Equations (3.15) and (3.16) are obtained by combining the (1,1) and (1,2) blocks of equation (2.6). Similarly, (3.17) and (3.18) are obtained by combining the (1,1) and (1,2) blocks of (3.26). See Bernstein and Haddad (1989) for details.  $\square$

**Remark 3.1:** Suppose  $x_{c0} = 0$  and consider initial conditions of the form  $\tilde{x}_0 = [x_0^\top \ 0]^\top$ . Then, since  $P_1 = P + \hat{P}$ , the set  $\mathcal{D} \times \{0\}$ , where  $\mathcal{D}$  is defined by

$$\mathcal{D} \triangleq \{x_0 \in \mathbf{R}^n : x_0^\top (P + \hat{P}) x_0 < V_0\} \quad (3.27)$$

is a subset of  $\tilde{\mathcal{D}}$  with  $V_0$  given by (2.8), and thus  $\mathcal{D} \times \{0\}$  is a subset of the domain of attraction.  $\square$

#### 4. Analysis of systems with amplitude and rate saturation nonlinearities

Consider the  $n$ th-order plant  $G(s)$  shown in Fig. 3 subjected to both amplitude saturation  $\sigma_s(\cdot)$  and rate saturation  $\sigma_{rs}(\cdot)$  given by

$$\dot{x}(t) = Ax(t) + B\sigma_{rs}(\sigma_s(u(t))) \quad (4.1)$$

$$y(t) = Cx(t) \quad (4.2)$$

with the controller (3.3), (3.4). For convenience, we use the shorthand notation  $u_{rs}(t)$  to denote  $\sigma_{rs}(\sigma_s(u(t)))$ . The amplitude saturation shown in Fig. 3 is defined as in § 2, so that  $\sigma_s(u) \triangleq [\sigma_{s1}(u_1) \cdots \sigma_{sm}(u_m)]^\top$ , where

$$\sigma_{si}(u_i) \triangleq \text{sat}_{\bar{u}_i}(u_i), \quad i = 1, \dots, m \quad (4.3)$$

and  $\bar{u}_1, \dots, \bar{u}_m$  are the independent amplitude saturation levels. The rate saturation function  $\sigma_{rs}(\cdot)$  in (4.1) is given in more detail in Fig. 4, where  $u_s \in \mathbf{R}^m$ ,  $v \in \mathbf{R}^m$ ,  $u_{rs} \in \mathbf{R}^m$ ,  $K = \text{diag}(K_1, \dots, K_m)$ ,  $K_i > 0$ ,  $i = 1, \dots, m$ ,  $\sigma_{ri}(v_i) \triangleq [\sigma_{r1}(v_1) \cdots \sigma_{rm}(v_m)]^\top$ , and

$$\sigma_{ri}(v_i) \triangleq \text{sat}_{\bar{v}_i}(v_i), \quad i = 1, \dots, m \quad (4.4)$$

where  $\bar{v}_i > 0$  is the rate saturation level,  $i = 1, \dots, m$ . The rate saturation model shown in Fig. 4 is a closed-loop position-feedback-type model with dynamics

$$\dot{u}_{rsi}(t) = \text{sat}_{\bar{v}_i}(K_i[u_{si}(t) - u_{rsi}(t)]), \quad u_{rsi}(0) = u_{rs0i}, \quad i = 1, \dots, m \quad (4.5)$$

where  $\dot{u}_{rsi}(t) = \sigma_{ri}(v_i(t))$ ,  $u_{si}(t) \triangleq \sigma_{si}(u_i(t))$ , and  $\text{sat}_{\bar{v}_i}$  enforces the rate saturation.

The rate saturation model (4.5) has two interpretations. First, it can be interpreted as a limitation on the speed of a servomechanism which is determined

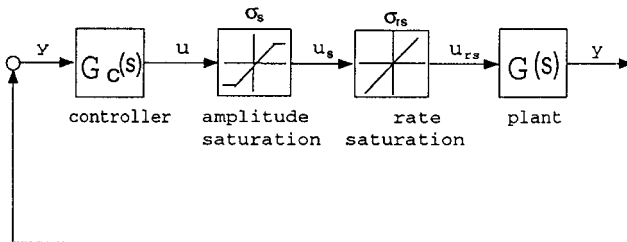

Figure 3. Closed-loop system with control amplitude and rate saturation nonlinearities.



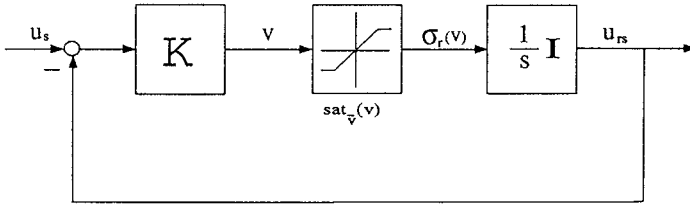

Figure 4. Rate saturation model  $\sigma_{rs}(\cdot)$ .

by the choice of  $K$ . In this case, the matrix  $K$  depends on the servo used so that  $K$  is a design parameter.

Alternatively, this model can be viewed as a continuous-time version of the discrete-time rate saturation model used by Kapasouris and Athans (1990) which is also closely related to the rate limiter model in Simulink (Mathworks 1993). By choosing  $K \gg I$ , the rate saturation model (4.5) coincides with the rate limiter model of Simulink. However, there is a discrepancy between these models when  $K = I$  as in Kapasouris and Athans (1990). The simulations given in Figs 5 and 6, show that as the gain  $K$  increases, the output from the rate saturation model (4.5) converges to the output of the rate limiter model of Simulink.

The saturation function inside the rate saturation loop can be extracted from the overall closed-loop system and written as shown in Fig. 7. This configuration has the closed-loop system realization

$$\dot{\tilde{x}}(t) = \tilde{A}\tilde{x}(t) + \tilde{B}[\sigma(\tilde{u}(t)) - \tilde{u}(t)], \quad \tilde{x}(0) = \tilde{x}_0 \tag{4.6}$$

$$\tilde{u}(t) = \tilde{C}\tilde{x}(t) + \tilde{D}[\sigma(\tilde{u}(t)) - \tilde{u}(t)] \tag{4.7}$$

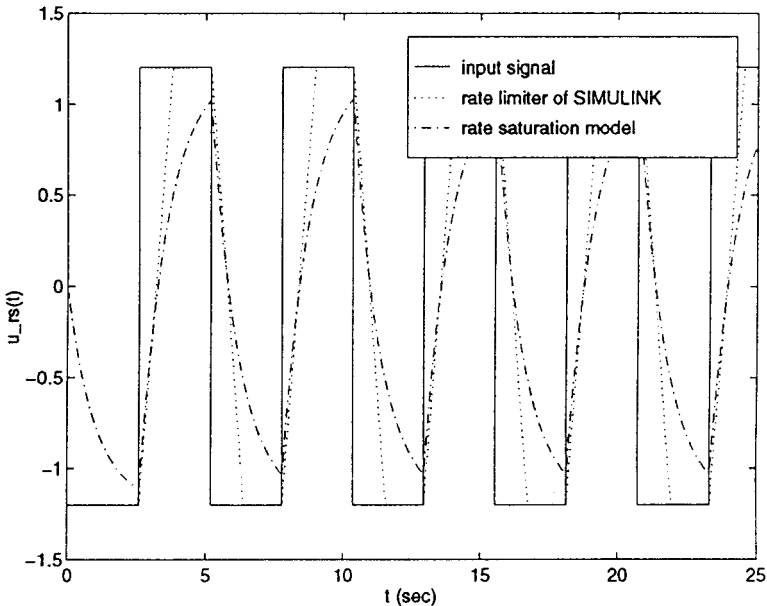

Figure 5. Comparison of the output of the rate limiter model of SIMULINK and the rate saturation model of Fig. 4 ( $\sigma_{rs}(u(0)) = 0, v_{max} = 2, K = 1$ ).

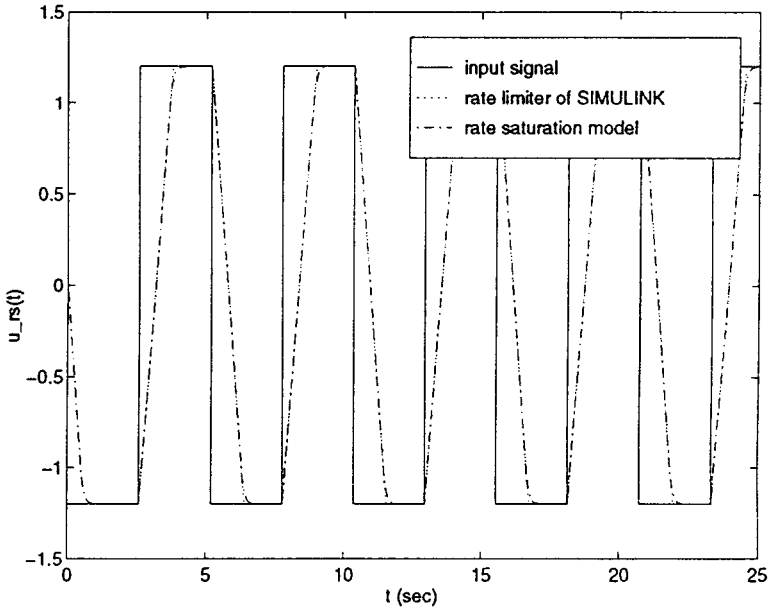

Figure 6. Comparison of the output of the rate limiter model of SIMULINK and the rate saturation model of Fig. 4 ( $\sigma_{rs}(u(0)) = 0, v_{max} = 2, K = 10$ ).

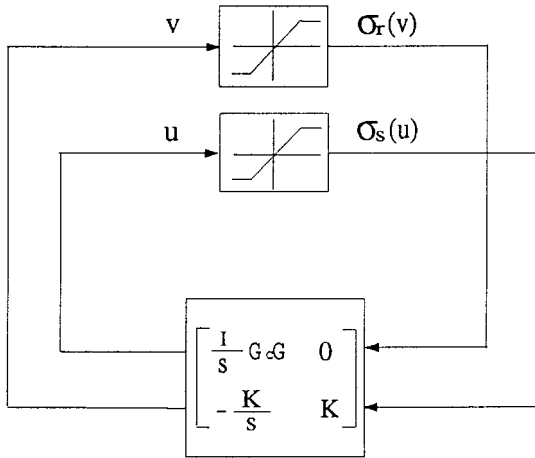

Figure 7. Closed-loop system with extracted amplitude and rate saturation nonlinearities.

where

$$\tilde{u} \triangleq \begin{bmatrix} u \\ v \end{bmatrix}, \quad \tilde{x} \triangleq \begin{bmatrix} x \\ u_{rs} \\ x_c \end{bmatrix}, \quad \tilde{x}_0 \triangleq \begin{bmatrix} x_0 \\ u_{rs0} \\ x_{c0} \end{bmatrix}$$

$$\sigma(\tilde{u}) \triangleq \begin{bmatrix} \sigma_s(u) \\ \sigma_r(v) \end{bmatrix}, \quad \sigma_s(u) \triangleq \begin{bmatrix} \sigma_{s1}(u_1) \\ \vdots \\ \sigma_{sm}(u_m) \end{bmatrix}, \quad \sigma_r(v) \triangleq \begin{bmatrix} \sigma_{r1}(v_1) \\ \vdots \\ \sigma_{rm}(v_m) \end{bmatrix}$$

and

$$\tilde{A} \triangleq \begin{bmatrix} A & B & 0 \\ 0 & -K & KC_c \\ B_c C & 0 & A_c \end{bmatrix}, \quad \tilde{B} \triangleq \begin{bmatrix} 0 & 0 \\ K & I \\ 0 & 0 \end{bmatrix}, \quad \tilde{C} \triangleq \begin{bmatrix} 0 & 0 & C_c \\ 0 & -K & KC_c \end{bmatrix}, \quad \tilde{D} \triangleq \begin{bmatrix} 0 & 0 \\ K & 0 \end{bmatrix}$$

With the rate saturation model given in Fig. 4, we have thus rewritten the system involving both amplitude and rate saturation nonlinearities as a system with amplitude saturation only. However, this transformation gives rise to a feedthrough term  $\tilde{D}$ , which did not appear in § 3. Because of this term, the stability analysis of the closed-loop system becomes more complicated than the case of pure amplitude saturation nonlinearity. We thus require the following result which is an extension of Theorem 4.1. For notational convenience, define

$$R_2 \triangleq \begin{bmatrix} R_{2u} & 0 \\ 0 & R_{2v} \end{bmatrix}, \quad R_0 \triangleq \begin{bmatrix} R_{0u} & 0 \\ 0 & R_{0v} \end{bmatrix}, \quad \beta_0 \triangleq \begin{bmatrix} \beta_{0u} & 0 \\ 0 & \beta_{0v} \end{bmatrix}$$

$$\tilde{R}_0 \triangleq R_0 + \frac{1}{2}[\tilde{D}^T(I - \beta_0)R_0 + R_0(I - \beta_0)\tilde{D}]$$

where

$$R_{2u} = \text{diag}(R_{2u1}, \dots, R_{2um}), \quad R_{2v} = \text{diag}(R_{2v1}, \dots, R_{2vm})$$

$$R_{0u} = \text{diag}(R_{0u1}, \dots, R_{0um}), \quad R_{0v} = \text{diag}(R_{0v1}, \dots, R_{0vm})$$

$$\beta_{0u} = \text{diag}(\beta_{0u1}, \dots, \beta_{0um}), \quad \beta_{0v} = \text{diag}(\beta_{0v1}, \dots, \beta_{0vm})$$

**Theorem 4.1:** Let  $\tilde{R}_1 \in \mathbf{N}^{\tilde{n}+m}$ ,  $K = \text{diag}(K_1, \dots, K_m)$ , and  $K_i > 0$ ,  $R_{2ui} > 0$ ,  $R_{2vi} > 0$ ,  $R_{0ui} > 0$ ,  $R_{0vi} > 0$ ,  $\beta_{0ui} \in [0, 1]$ ,  $\beta_{0vi} \in [0, \min\{1, \bar{v}_i/(2K_i\bar{u}_i)\}]$ ,  $i = 1, \dots, m$ . In addition, assume that  $\tilde{R}_0$  is positive definite and  $(\tilde{A}, \tilde{C})$  is observable. Furthermore, suppose there exists  $\tilde{P} \in \mathbf{P}^{\tilde{n}}$  satisfying

$$0 = \tilde{A}^T \tilde{P} + \tilde{P} \tilde{A} + \tilde{R}_1 + \tilde{C}^T R_2 \tilde{C} + \frac{1}{2}[\tilde{B}^T \tilde{P} - R_0(I - \beta_0)\tilde{C}]^T \tilde{R}_0^{-1}[\tilde{B}^T \tilde{P} - R_0(I - \beta_0)\tilde{C}] \quad (4.8)$$

Then the closed-loop system (4.6), (4.7) is asymptotically stable with Lyapunov function  $V(\tilde{x}) = \tilde{x}^T \tilde{P} \tilde{x}$ , and the set

$$\tilde{\mathcal{D}} \triangleq \{\tilde{x}_0 \in \mathbf{R}^{\tilde{n}+m} : V(\tilde{x}_0) < V_0, |u_{rs0i}| \leq \bar{u}_i, i = 1, \dots, m\} \quad (4.9)$$

is a subset of the domain of attraction of the closed-loop system, where

$$V_0 \triangleq \min \{\bar{u}_i^2 / (\beta_{0i}^2 \tilde{C}_i \tilde{P}^{-1} \tilde{C}_i^T) : i = 1, \dots, m\}$$

$\tilde{C}_i$  is the  $i$ th row of  $\tilde{C}$ ,  $i = 1, \dots, m$ , and

$$\beta_{0i} \triangleq \max \left\{ 0, \frac{1}{2} \left[ 1 + \beta_{0ui} - \left\{ (1 - \beta_{0ui})^2 + 2R_{2ui}R_{0ui}^{-1} \right\}^{1/2} \right] \right\}, \quad i = 1, \dots, m$$

**Proof:** For the proof see the Appendix.  $\square$

Theorem 4.1 requires that  $\tilde{R}_0$  be positive definite which places a constraint on the relationship between  $K$ ,  $\beta_0$  and  $R_0$ . In particular

$$\tilde{R}_0 = \begin{bmatrix} R_{0u} & \frac{1}{2}K(I - \beta_{0v})R_{0v} \\ \frac{1}{2}R_{0v}(I - \beta_{0v})K & R_{0v} \end{bmatrix} > 0$$

implies that  $R_{0u} - \frac{1}{4}K(I - \beta_{0v})R_{0v}(I - \beta_{0v})K > 0$ . However, note that equation (4.7)

can be written in detail as

$$\begin{aligned} u(t) &= C_c x_c(t) \\ v(t) &= -K u_{rs}(t) + K(\sigma_s(u(t)) - u(t)) \end{aligned}$$

which indicates that the size of  $K$  is not constrained by equation (4.7).

## 5. Linear controller synthesis of systems with independent amplitude and rate saturation

In this section, we consider the closed-loop system (4.6), (4.7), and apply the same technique as in § 3 to obtain linear dynamic compensators. Again our goal is to determine gains  $A_c, B_c, C_c$  that minimize the LQG-type cost

$$J(A_c, B_c, C_c) = \text{tr } \tilde{P} \tilde{V}$$

where

$$\tilde{V} = \begin{bmatrix} V_1 & 0 \\ 0 & B_c V_2 B_c^T \end{bmatrix}$$

$\tilde{P}$  satisfies (4.8), and  $V_1 \in \mathbf{N}^{n+m}$  and  $V_2 \in \mathbf{P}^l$  are analogous to the plant disturbance and measurement noise intensity matrices of LQG theory, respectively. Furthermore, let

$$\tilde{R}_1 = \begin{bmatrix} R_1 & 0 \\ 0 & 0 \end{bmatrix}$$

where  $R_1 \in \mathbf{N}^{n+m}$ . For notational convenience, we define

$$\begin{aligned} A_a &\triangleq \begin{bmatrix} A & B \\ 0 & -K \end{bmatrix}, \quad B_{a1} \triangleq \begin{bmatrix} 0 \\ K \end{bmatrix}, \quad B_{a2} \triangleq \begin{bmatrix} 0 \\ I \end{bmatrix}, \quad B_a \triangleq [B_{a1} \quad B_{a2}], \quad C_a \triangleq [C \quad 0] \\ C_1 &\triangleq \begin{bmatrix} 0 & 0 \\ 0 & -K \end{bmatrix}, \quad C_2 \triangleq \begin{bmatrix} I \\ K \end{bmatrix}, \quad \tilde{D} \triangleq \begin{bmatrix} 0 & 0 \\ K & 0 \end{bmatrix} \\ R_{20} &\triangleq \frac{1}{2}(I - \beta_0)R_0 \tilde{R}_0^{-1} R_0 (I - \beta_0), \quad R_{2a} \triangleq C_2^T (R_2 + R_{20}) C_2 \\ \Sigma_0 &\triangleq \frac{1}{2} B_a \tilde{R}_0^{-1} B_a^T, \quad \tilde{\Sigma} \triangleq C_a^T V_2^{-1} C_a, \quad \Sigma \triangleq B_P R_{2a}^{-1} B_P^T \end{aligned}$$

and

$$\begin{aligned} A_P &\triangleq A_a - \frac{1}{2} B_a \tilde{R}_0^{-1} (I - \beta_0) C_1, \quad B_P \triangleq B_{a1} - \frac{1}{2} B_a \tilde{R}_0^{-1} (I - \beta_0) C_2 \\ C_P &\triangleq C_2^T (R_2 + R_{20}) C_1, \quad A_{\hat{Q}} \triangleq A_P + \Sigma_0 P - B_P R_{2a}^{-1} (B_P^T P + C_P) \end{aligned}$$

We first consider the full-order case.

**Proposition 5.1:** *Let  $n_c = n$ , suppose there exist  $n \times n$  non-negative-definite matrices  $P, Q, \hat{P}$  satisfying*

$$\begin{aligned} 0 &= A_P^T P + P A_P + R_1 + C_1^T (R_2 + R_{20}) C_1 + P \Sigma_0 P \\ &\quad - (B_P^T P + C_P)^T R_{2a}^{-1} (B_P^T P + C_P) \end{aligned} \quad (5.1)$$

$$\begin{aligned} 0 &= (A_P - Q \tilde{\Sigma} + \Sigma_0 P)^T \hat{P} + \hat{P} (A_P - Q \tilde{\Sigma} + \Sigma_0 P) + \hat{P} \Sigma_0 \hat{P} \\ &\quad + (B_P^T P + C_P)^T R_{2a}^{-1} (B_P^T P + C_P) \end{aligned} \quad (5.2)$$

$$0 = [A_P + \Sigma_0 (P + \hat{P})] Q + Q [A_P + \Sigma_0 (P + \hat{P})]^T + V_1 - Q \tilde{\Sigma} Q \quad (5.3)$$

and let  $A_c, B_c, C_c$  be given by

$$A_c = A_P + \Sigma_0 P + B_P C_c - B_c C_a \quad (5.4)$$

$$B_c = Q C_a^T V_2^{-1} \quad (5.5)$$

$$C_c = -R_{2a}^{-1} (B_P^T P + C_P) \quad (5.6)$$

Furthermore, suppose that  $(\tilde{A}, \tilde{C})$  is observable. Then

$$\tilde{P} = \begin{bmatrix} P + \hat{P} & -\hat{P} \\ -\hat{P} & \hat{P} \end{bmatrix}$$

satisfies (2.6), and  $(A_c, B_c, C_c)$  is an extremal of  $J(A_c, B_c, C_c)$ . Furthermore, the closed-loop system (2.1), (2.2) is asymptotically stable, and  $\mathcal{D}$  defined by (4.9) is a subset of the domain of attraction of the closed-loop system.

**Proof:** The proof is similar to the proof of Proposition 5.2 below with  $n_c = n$  and  $\Gamma = G^T = \tau = I$ .  $\square$

Next we consider the reduced-order case  $n_c \leq n$ .

**Proposition 5.2:** Let  $n_c \leq n$ , suppose there exist  $n \times n$  non-negative-definite matrices  $P, Q, \hat{P}, \hat{Q}$  satisfying

$$0 = A_P^T P + P A_P + R_1 + C_1^T (R_2 + R_{20}) C_1 + P \Sigma_0 P - (B_P^T P + C_P)^T R_{2a}^{-1} (B_P^T P + C_P) + \tau_{\perp}^T (B_P^T P + C_P)^T R_{2a}^{-1} (B_P^T P + C_P) \tau_{\perp} \quad (5.7)$$

$$0 = (A_P - Q \bar{\Sigma} + \Sigma_0 P)^T \hat{P} + \hat{P} (A_P - Q \bar{\Sigma} + \Sigma_0 P) + \hat{P} \Sigma_0 \hat{P} + (B_P^T P + C_P)^T R_{2a}^{-1} (B_P^T P + C_P) - \tau_{\perp}^T (B_P^T P + C_P)^T R_{2a}^{-1} (B_P^T P + C_P) \tau_{\perp} \quad (5.8)$$

$$0 = [A_P + \Sigma_0 (P + \hat{P})] Q + Q [A_P + \Sigma_0 (P + \hat{P})]^T + V_1 - Q \bar{\Sigma} Q + \tau_{\perp} Q \bar{\Sigma} Q \tau_{\perp}^T \quad (5.9)$$

$$0 = A_Q \hat{Q} + \hat{Q} A_Q^T + Q \bar{\Sigma} Q - \tau_{\perp} Q \bar{\Sigma} Q \tau_{\perp}^T \quad (5.10)$$

and let  $A_c, B_c, C_c$  be given by

$$A_c = \Gamma (A_P + \Sigma_0 P) G^T + \Gamma B_P C_c - B_c C_a G^T \quad (5.11)$$

$$B_c = \Gamma Q C_a^T V_2^{-1} \quad (5.12)$$

$$C_c = -R_{2a}^{-1} (B_P^T P + C_P) G^T \quad (5.13)$$

Furthermore, suppose that  $(\tilde{A}, \tilde{C})$  is observable. Then

$$\tilde{P} = \begin{bmatrix} P + \hat{P} & -\hat{P} G^T \\ -G \hat{P} & G \hat{P} G^T \end{bmatrix}$$

satisfies (2.6), and  $(A_c, B_c, C_c)$  is an extremal of  $J(A_c, B_c, C_c)$ . Furthermore, the closed-loop system (2.1), (2.2) is asymptotically stable, and  $\mathcal{D}$  defined by (4.9) is a subset of the domain of attraction of the closed-loop system.

**Proof:** The proof is analogous to the proof of Proposition 3.2.  $\square$

## 6. Numerical examples

In this section, we consider the example given by Rodriguez and Cloutier (1994) to demonstrate the ability of the full-order compensators given by Propositions 3.1 and 5.1 to address amplitude and rate saturation. To solve the synthesis equations (3.6)–(3.8) and (5.1)–(5.3), we utilize the iterative method given in Tyan and Bernstein (1995 a) initialized with LQG gains. Starting with the solution  $P$  of (3.6) or (5.1), we then solve (3.7)–(3.8) or (5.2)–(5.3) iteratively until convergence is achieved. Although guarantees of convergence are not available, this algorithm has been shown to work effectively in practice.

**Example 6.1:** To demonstrate dynamical controllers given by Proposition 3.1 dealing with independent input saturation nonlinearities, we consider the asymptotically stable open-loop system  $G_p(s)$  with realization

$$\dot{x}_p(t) = A_p x_p(t) + B_p \sigma(u(t)), \quad x_p(0) = x_{p0} \quad (6.1)$$

$$y(t) = C_p x_p(t) \quad (6.2)$$

where

$$x_p \triangleq \begin{bmatrix} \text{side slip (deg)} \\ \text{yaw rate (deg s}^{-1}\text{)} \\ \text{roll rate (deg s}^{-1}\text{)} \end{bmatrix}, \quad u \triangleq \begin{bmatrix} \text{rudder (deg)} \\ \text{aileron (deg)} \end{bmatrix}, \quad y \triangleq \begin{bmatrix} \text{side slip (deg)} \\ \text{yaw rate (deg s}^{-1}\text{)} \end{bmatrix}$$

$$A_p = \begin{bmatrix} -0.818 & -0.999 & 0.349 \\ 80.29 & -0.579 & 0.009 \\ -2734 & 0.5621 & -2.10 \end{bmatrix}, \quad B_p = \begin{bmatrix} 0.147 & 0.012 \\ -194.4 & 37.61 \\ -2176 & -1093 \end{bmatrix}, \quad C_p = \begin{bmatrix} 1 & 0 & 0 \\ 0 & 1 & 0 \end{bmatrix}$$

and the saturation nonlinearity  $\sigma(u(t)) = [\sigma_1(u_1(t)) \ \sigma_2(u_2(t))]^T$  given by

$$\sigma_i(u_i(t)) = \text{sat}_8(u_i(t)), \quad i = 1, 2$$

To track step input commands, we consider the closed-loop-system configuration shown in Fig. 8. For design purposes, we interchange  $(1/s)I_2$  and the saturation nonlinearity so that we have the pseudo-equivalent configuration given in Fig. 9. Next we consider the realization of the augmented plant  $G_p(s)/s$  with the step input command  $r$  given by

$$\begin{bmatrix} \dot{x}_p(t) \\ \dot{e}(t) \end{bmatrix} = \begin{bmatrix} A_p & 0 \\ -C_p & 0 \end{bmatrix} \begin{bmatrix} x_p(t) \\ e(t) \end{bmatrix} + \begin{bmatrix} B_p \\ 0 \end{bmatrix} \sigma(u(t)), \quad \begin{bmatrix} x_p(0) \\ e(0) \end{bmatrix} = \begin{bmatrix} x_{p0} \\ e_0 \end{bmatrix} \quad (6.3)$$

$$e(t) = \begin{bmatrix} 0 & I \end{bmatrix} \begin{bmatrix} x_p(t) \\ e(t) \end{bmatrix} \quad (6.4)$$

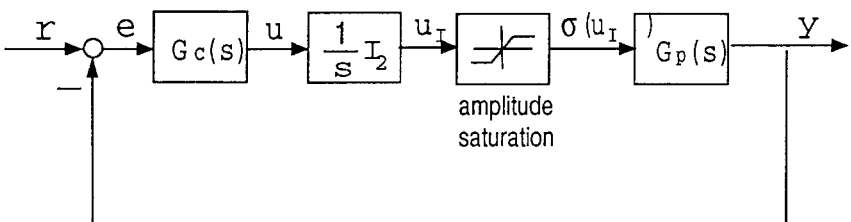

Figure 8. Closed-loop system for Example 6.1.

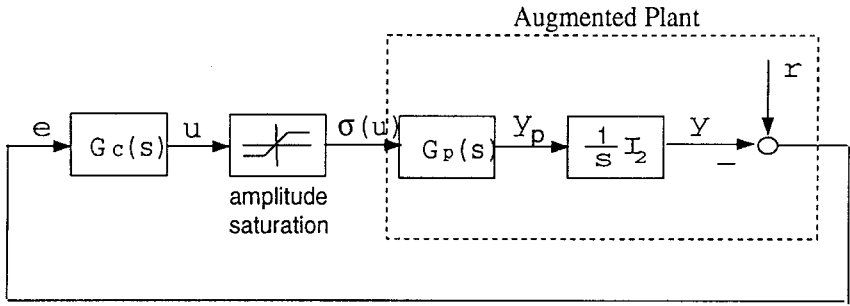

Figure 9. Pseudo-equivalent configuration of Example 6.1.

where  $e(t) = r - y(t)$ . The dynamic controller has the realization

$$\begin{aligned} \dot{x}_c(t) &= A_c x_c(t) + B_c e(t), \quad x_c(0) = x_{c0} \\ u(t) &= C_c x_c(t) \end{aligned}$$

Choosing  $R_1 = \text{diag}[1 \ 1 \ 1 \ 5000 \ 50 \ 000]$ ,  $R_2 = I_2$ ,  $V_1 = R_1$ ,  $V_2 = I_2$ ,  $\beta_0 = 0.8I_2$ , and  $R_0 = 10^6 I_2$  yields the linear controller (3.3), (3.4) with gains (3.9)–(3.11) given by

$$A_c = \begin{bmatrix} -7.7185e-01 & -9.8460e-01 & 3.4989e-01 & 5.9631e-02 & 3.1160e+00 \\ 1.7445e+01 & -2.0643e+01 & -1.0077e+00 & 7.4092e+00 & 1.0762e+03 \\ -3.3860e+03 & -1.9503e+02 & -1.7863e+01 & 6.7207e+02 & 5.0822e+03 \\ -1.0000e+00 & 0 & 0 & -7.0712e+01 & -4.5657e-02 \\ 0 & -1.0000e+00 & 0 & -4.5657e-02 & -2.2714e+02 \end{bmatrix}$$

$$B_c = \begin{bmatrix} -7.5317e-02 & -3.3186e+00 \\ -1.0280e+01 & -7.9633e+02 \\ -3.5658e+01 & -2.2879e+03 \\ 7.0712e+01 & 4.5657e-02 \\ 4.5657e-02 & 2.2714e+02 \end{bmatrix}$$

$$C_c = \begin{bmatrix} 3.5629e-01 & 1.1194e-01 & 6.5137e-03 & -7.9496e-02 & -1.5710e+00 \\ -3.8233e-02 & -2.1541e-02 & 3.2569e-03 & -4.9678e-01 & 2.5139e-01 \end{bmatrix}$$

To illustrate the closed-loop behaviour, let the initial conditions of the closed-loop system be  $\tilde{x}_0^T = [x_0^T \ x_{c0}^T]$ , where  $x_0^T = [x_{p0}^T \ e_0^T] = [0_{1 \times 3} \ r^T]$ ,  $x_{c0} = 0_{5 \times 1}$ , with the step input command  $r = [4 \ 2 \ -4 \ 2]^T$ . By applying Remark 3.1,  $\mathcal{D}$  is given by  $\mathcal{D} = \{x_0 : x_0^T (P + \hat{P}) x_0 < 4.1615 \times 10^3\}$ , where

$$P + \hat{P} = \begin{bmatrix} 1.8880e+03 & 2.9894e+00 & -4.1954e-01 & -1.5664e+02 & -6.9950e+02 \\ 2.9894e+00 & 7.2237e+01 & 1.6531e+00 & 8.4144e+01 & 3.4613e+01 \\ -4.1954e-01 & 1.6531e+00 & 2.9270e-01 & -7.7307e+00 & 6.1835e+00 \\ -1.5664e+02 & 8.4144e+01 & -7.7307e+00 & 2.6946e+04 & 1.1531e+02 \\ -6.9950e+02 & 3.4613e+01 & 6.1835e+00 & 1.1531e+02 & 5.1121e+03 \end{bmatrix}$$

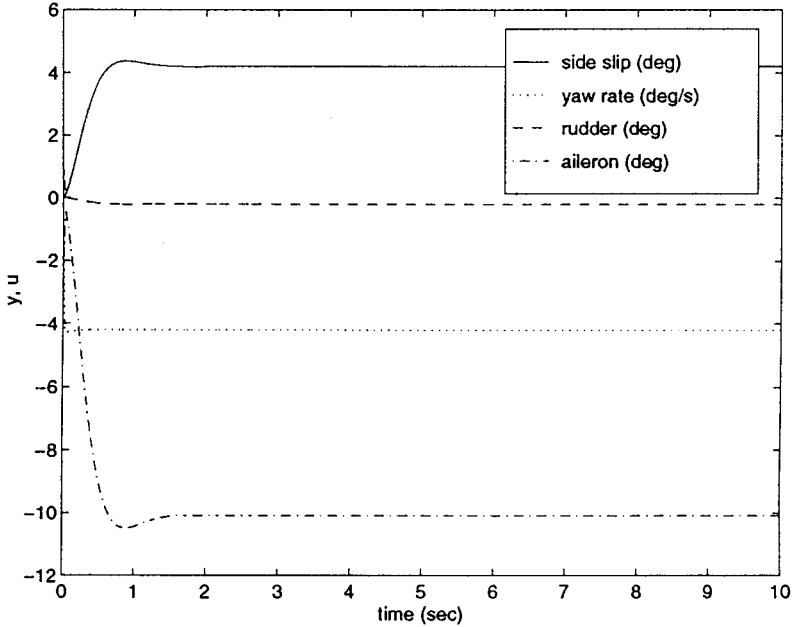

Figure 10. Response (side slip, yaw rate) of system (6.1), (6.2) and control effort  $u$  (rudder, aileron) using the LQG controller for Example 6.1 without amplitude saturation present.

Note that  $x_0^T(P + \hat{P})x_0 = 5.6143 \times 10^5$ , so that  $x_0$  is not an element of  $\mathcal{S}$ . Figure 10 shows the output of the system and control effort using the LQG controller without saturation. As can be seen in Fig. 11, the response of the closed-loop system consisting of the saturation nonlinearity and the LQG controller designed for the ‘unsaturated’ plant is unacceptable. Figure 12 shows the saturated input of the LQG controller. However, the controller designed by Proposition 3.1 provides an asymptotically stable closed-loop system (see Fig. 13). Since  $(1/s)I$  and the saturation nonlinearity were interchanged, the side slip of  $y$  exhibits steady-state errors. Finally, Fig. 14 shows the saturated input  $\sigma(u(t))$  for the controller obtained from Proposition 3.1. As shown in the figure, the controller is free to saturate during closed-loop operation without loss of stability.  $\square$

**Example 6.2:** To demonstrate Proposition 5.1 involving rate saturation, we consider the configuration shown in Fig. 15, where the asymptotically stable open-loop system  $G_p(s)$  has the same realization (6.1), (6.2) as in Example 6.1. To track step input commands, we let our dynamic compensator be  $G_c(s)/s$ . Again, for design purposes, we interchange  $(1/s)I_2$  with both the amplitude and rate saturation nonlinearities inside the feedback loop, so that we have the pseudo-equivalent configuration given by Fig. 16. The rate limited actuator is modelled as a position type feedback system

$$\dot{u}_{rsi}(t) = \text{sat}_{\bar{v}_i}(K_i[u_{si}(t) - u_{rsi}(t)]), \quad u_{rsi}(0) = u_{rs0i}, \quad i = 1, 2$$

with rate saturation level  $\bar{v}_1 = \bar{v}_2 = 4$ , and the actuator constant  $K_1 = K_2 = 10$ .

We first consider the controller  $A_c, B_c, C_c$  obtained from Example 6.1 in the presence of a rate-limited actuator. As can be seen in Fig. 17, this controller does not



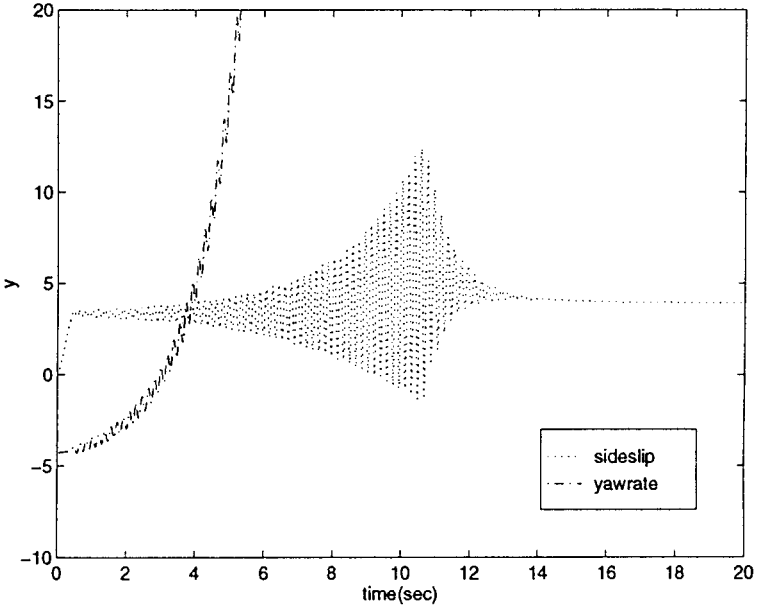

Figure 11. Output of system (6.1), (6.2) using the LQG controller for Example 6.1 with amplitude saturation present.

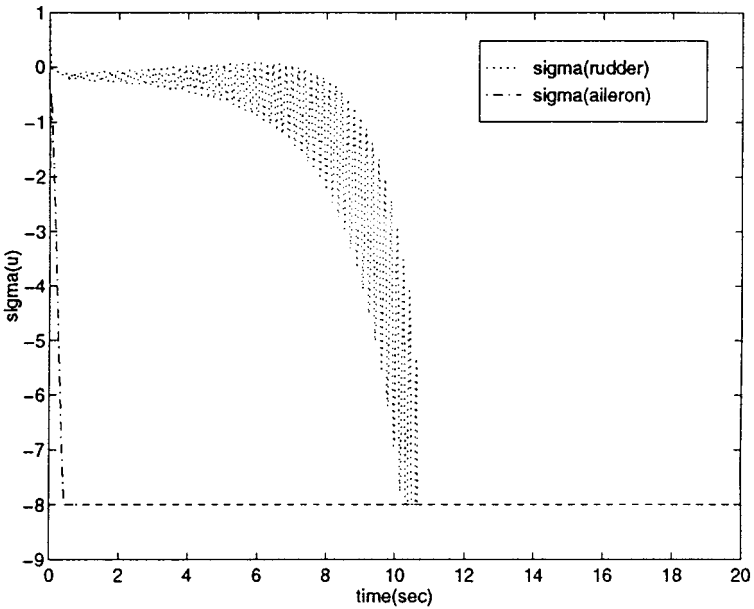

Figure 12. Saturated input  $\sigma(u)$  of the LQG controller for Example 6.1 with amplitude saturation present.

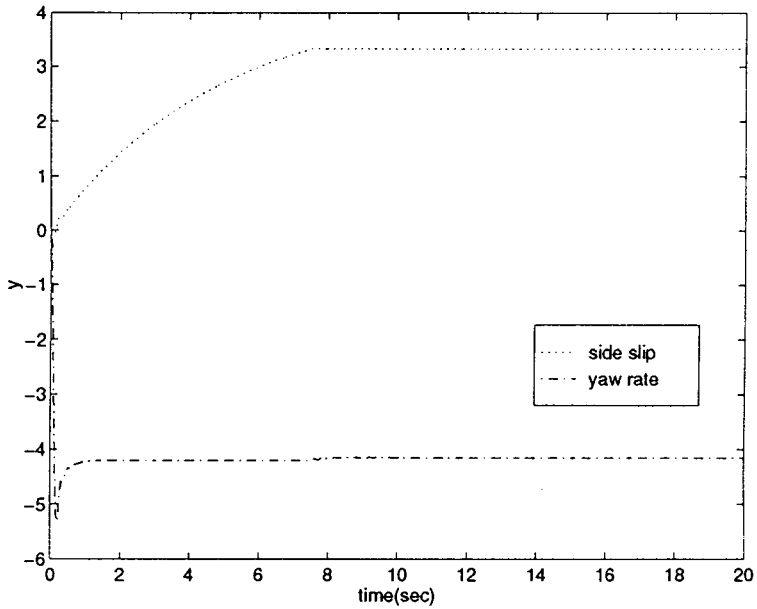

Figure 13. Response of system (6.1), (6.2) using the controller given by Proposition 3.1 for Example 6.1 with amplitude saturation present.

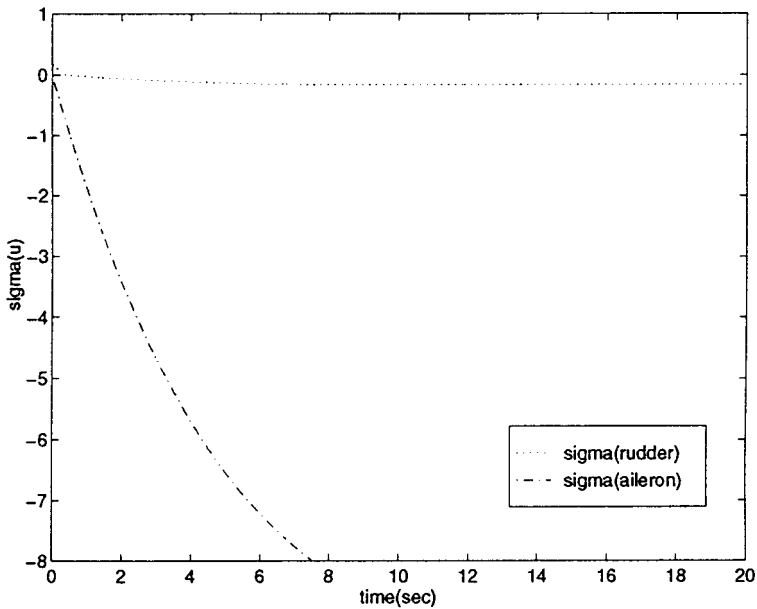

Figure 14. Saturated input  $\sigma(u)$  of the controller given by Proposition 3.1 for Example 6.1 with amplitude saturation present.

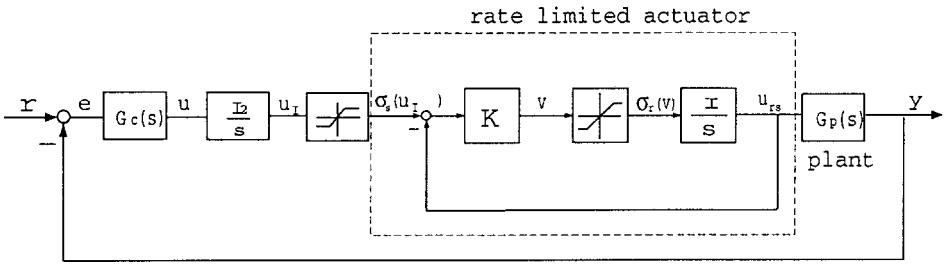

Figure 15. Closed-loop system of Example 6.2.

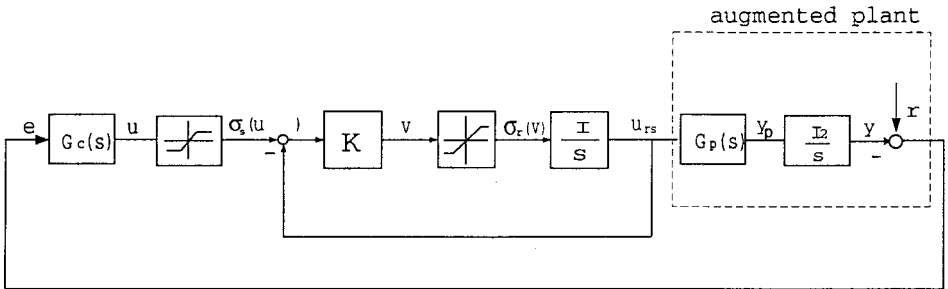

Figure 16. Pseudo-equivalent closed-loop system of Example 6.2.

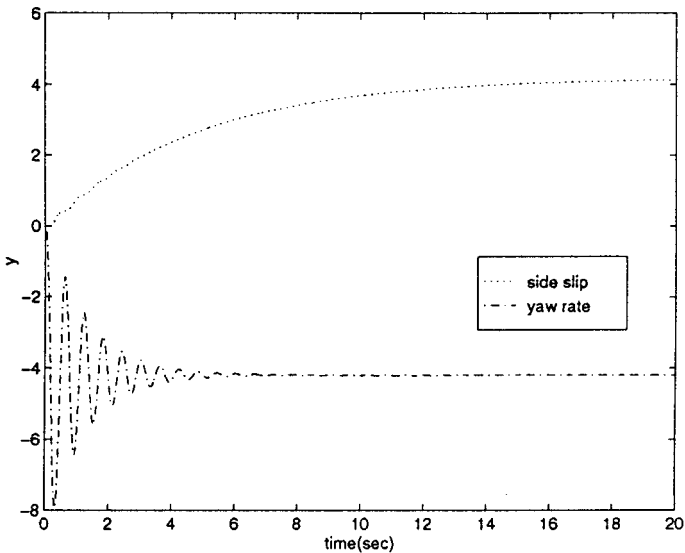

Figure 17. Response of system shown in Fig. 15 using controller given by Proposition 3.1 for Example 6.1 with amplitude and rate saturation present.

give satisfactory transient yaw rate due to the rate saturation. We thus apply Proposition 5.1 to account for this effect. As in Example 6.1 we consider the realization of the augmented plant  $G_p(s)/s$  plus the step input command  $r$  given by

$$\begin{bmatrix} \dot{x}_p(t) \\ e(t) \end{bmatrix} = \begin{bmatrix} A_p & 0 \\ -C_p & 0 \end{bmatrix} \begin{bmatrix} x_p(t) \\ e(t) \end{bmatrix} + \begin{bmatrix} B_p \\ 0 \end{bmatrix} \sigma_{rs}(\sigma_s(u(t)))$$

$$e(t) = \begin{bmatrix} 0 & I \end{bmatrix} \begin{bmatrix} x_p(t) \\ e(t) \end{bmatrix}$$

and the saturation nonlinearity  $\sigma_s(u(t)) = [\sigma_{s1}(u_1(t)) \ \sigma_{s2}(u_2(t))]^T$  given by

$$\sigma_{si}(u_i(t)) = \text{sat}_{10}(u_i(t)), \quad i = 1, 2$$

Furthermore, the dynamic controller has the realization

$$\begin{aligned} \dot{x}_c &= A_c x_c + B_c e \\ u &= C_c x_c \end{aligned}$$

Choosing  $R_1 = \text{diag}[1 \ 1 \ 1 \ 5000 \ 50 \ 000 \ 1 \ 1]$ ,  $R_2 = I_2$ ,  $V_1 = R_1$ ,  $V_2 = I_2$ ,  $\beta_0 = \text{diag}[1 \ 1 \ 0.9 \ 0.9]$ ,  $R_0 = \text{diag}[10^{12} \ 10^{12} \ 10^6 \ 10^6]$ , yields the linear controller (3.3), (3.4) with gains (5.4)–(5.6) given by

$$A_c = \begin{bmatrix} -8.1800e-01 & -9.9900e-01 & 3.4900e-01 & 3.3611e-03 & 2.9873e-02 & 1.4700e-01 & 1.2000e-02 \\ 8.0290e+01 & -5.7900e-01 & 9.0000e-03 & 9.9509e-02 & 6.1532e+01 & -1.9440e+02 & 3.7610e+01 \\ -2.7340e+03 & 5.6210e-01 & -2.1000e+00 & 1.8607e-01 & 1.7597e-02 & -2.1760e+03 & -1.0930e+03 \\ -1.0000e+00 & 0 & 0 & -7.0711e+01 & -4.3919e-04 & 0 & 0 \\ 0 & -1.0000e+00 & 0 & -4.3919e-04 & -2.2388e+02 & 0 & 0 \\ 1.7962e-01 & 5.7856e-01 & 1.7551e-02 & -4.4626e-02 & -3.2023e+00 & -1.7352e+01 & 4.2455e-01 \\ -1.0654e-01 & -2.3269e-02 & -3.1276e-04 & -9.4996e-01 & 1.4357e-01 & 4.2455e-01 & -9.4300e-01 \end{bmatrix}$$

$$B_c = \begin{bmatrix} -3.3611e-03 & -2.9873e-02 \\ -9.9509e-02 & -6.1532e+01 \\ -1.8607e-01 & -1.7597e+02 \\ 7.0711e+01 & 4.3919e-04 \\ 4.3919e-04 & 2.2388e+02 \\ 7.0980e-04 & 2.0554e-01 \\ 2.3058e-03 & -4.6952e-03 \end{bmatrix}$$

$$C_c = \begin{bmatrix} -1.8960e-02 & 6.1070e-02 & 1.8526e-03 & -4.6356e-03 & -3.1632e-01 & -8.3160e-01 & 4.4813e-02 \\ -1.1246e-02 & -2.4561e-03 & -3.3014e-05 & -1.0003e-01 & 1.4659e-02 & 4.4813e-02 & 9.0046e-01 \end{bmatrix}$$

To illustrate the closed-loop behaviour, let the initial conditions of the closed-loop system be  $\tilde{x}_0 = [x_{p0}^T \ e(0)^T \ u_{rs0}^T \ x_{c0}^T]^T = [0_{1 \times 3} \ r^T \ 0_{1 \times 2} \ 0_{1 \times 7}]^T$  where the step input command  $r = [4.2 \ -4.2]^T$ . For convenience, define  $x_0 = [x_{p0}^T \ e(0)^T \ u_{rs0}^T]^T$ . Using Remark 3.1,  $\mathcal{D}$  is given by  $\mathcal{D} = \{x_0 : x_0^T(P + \hat{P})x_0 < 1.023 \times 10^5\}$ . Note that  $x_0^T(P + \hat{P})x_0 = 4.025 \times 10^5$ , so that  $x_0$  is not an element of  $\mathcal{D}$ . Also,  $\beta_0$  corresponding to rate saturation is chosen to be  $\text{diag}(0.9, 0.9)$  whose diagonal elements are

larger than the value  $\beta_{0vi} \in \left[0, \frac{10}{2 \times 10 \times 4}\right]$ ,  $i = 1, 2$ , given by Theorem 4.1. Figure 18

shows the response and control signals of the closed-loop system using the LQG controller without amplitude and rate saturation present. Figures 19, 20 illustrate the output and saturated input  $\sigma(u(t))$  for the LQG controller with both amplitude and rate saturation present. However, as shown in Fig. 21 the controller designed by Proposition 5.1 provides an asymptotically stable closed-loop system.

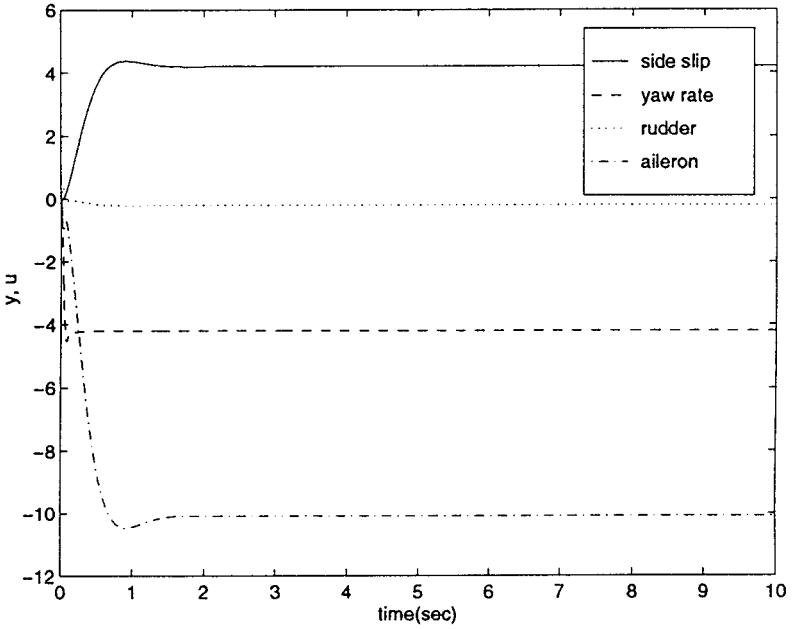

Figure 18. Response (side slip, yaw rate) of system (6.1), (6.2) and control effort  $u$  (rudder, aileron) using the LQG controller for Example 6.2 without amplitude and rate saturation present.

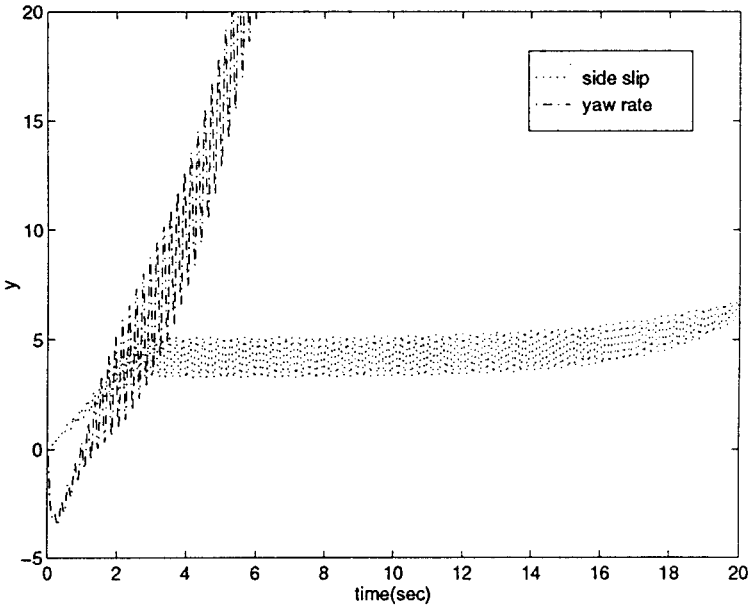

Figure 19. Output of system (6.1), (6.2) using the LQG controller for Example 6.2 with both amplitude and rate saturation present.

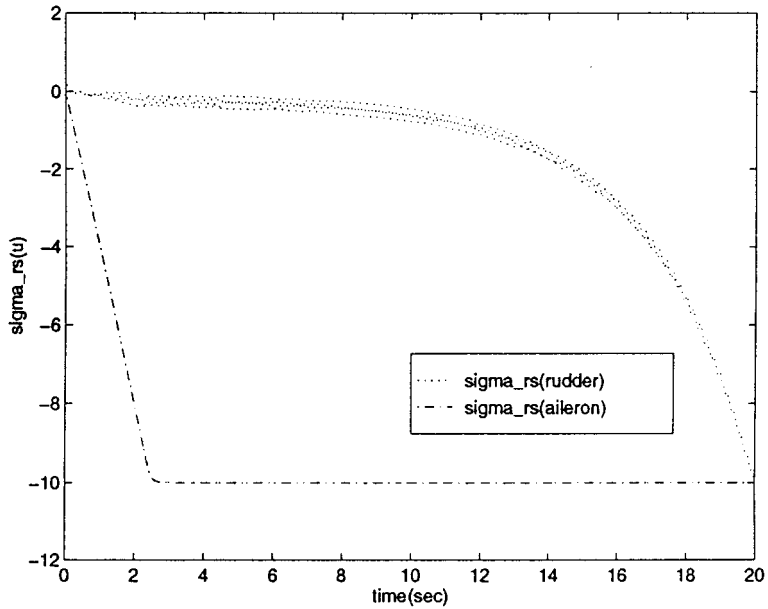

Figure 20. Saturated input  $\sigma_{rs}(u(t))$  of the LQG controller for Example 6.2 with both amplitude and rate saturation present.

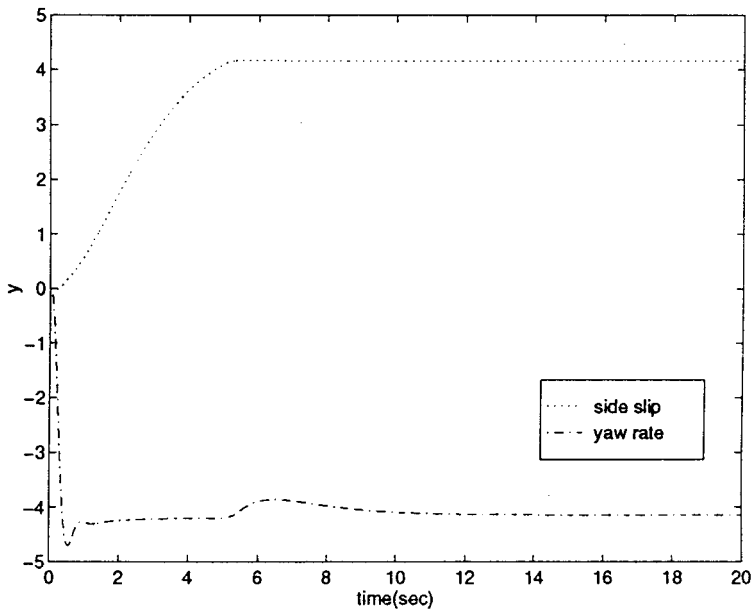

Figure 21. Output of system (6.1), (6.2) using the controller given by Proposition 5.1 for Example 6.2 with both amplitude and rate saturation present.

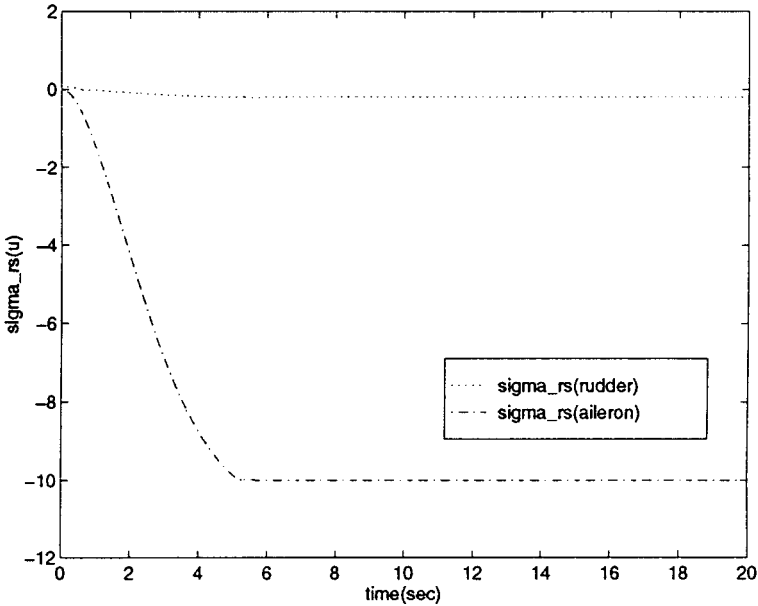

Figure 22. Saturated input  $\sigma_{rs}(u(t))$  of the controller given by Proposition 5.1 for Example 6.2 with both amplitude and rate saturation present.

Figure 22 shows that this controller tends to reduce the rate of the control signal  $u(t)$  so that  $u(t)$  does not reach the rate limit boundary during the entire process.

## 7. Conclusions

In this paper, we developed full- and reduced-order linear dynamic compensators based upon Theorem 2.1 and Theorem 4.1, which account for independent input saturation and rate saturation nonlinearities, respectively. Theorem 4.1 extends Theorem 2.1 to address the more involved feedthrough term. A guaranteed domain of attraction is provided by means of a positive-real-type Riccati equation. Although the domain of attraction provided by this paper is conservative, we can treat the matrix  $\beta_0$  as a design parameter. By decreasing the value of the diagonal elements of  $\beta_0$ , we can improve the system response for larger plant initial conditions  $x_0$ . However, the lowest possible values of  $\beta_0$  are constrained by the open-loop system. Controller gains were characterized by Riccati equations that were obtained by minimizing an LQG-type cost. The synthesis approach was demonstrated by numerical examples involving full-order dynamic compensators. From these examples, it was seen that smaller  $\beta_0$  tends to let the saturation occur later. A numerical algorithm based upon Greeley and Hyland (1988) was adopted for solving the coupled design equations. More sophisticated algorithms based upon homotopy methods can also be developed, as in Ge *et al.* (1994); however, this approach is beyond the scope of this paper. Future research includes improving the guaranteed domain of attraction and the analysis of the necessary conditions of the existence of the non-negative-definite solutions  $P, Q, \hat{P}, \hat{Q}$  in those design equations. Finally, a reformulation of design equations in terms of linear matrix inequalities may help to ensure the existence of solutions to the design equations.

## ACKNOWLEDGMENT

The authors wish to acknowledge the referees for providing invaluable comments and suggestions and for bringing Remark 2.2 to their attention.

This research was supported in part by the Air Force Office of Scientific Research under grant F49620-95-1-0019.

## Appendix

**Proof of Theorem 2.1:** First note that by using (2.1) and (2.2),  $\dot{V}(\tilde{x}(t))$  can be written as

$$\dot{V}(\tilde{x}(t)) = - \begin{bmatrix} \tilde{x}^T(t) & \phi^T(u(t)) \end{bmatrix} \begin{bmatrix} -\tilde{A}^T \tilde{P} - \tilde{P} \tilde{A} & \tilde{P} \tilde{B} \\ \tilde{B}^T \tilde{P} & 0 \end{bmatrix} \begin{bmatrix} \tilde{x}(t) \\ \phi(u(t)) \end{bmatrix}$$

where  $\phi(u) \triangleq u - \sigma(u)$ . Adding and subtracting  $2[u^T(t)(I_m - \beta_0) - \phi^T(u(t))]R_0\phi(u(t))$  and using (2.6) yields

$$\begin{aligned} \dot{V}(\tilde{x}(t)) &= - \begin{bmatrix} \tilde{x}^T(t) & \phi^T(u(t)) \end{bmatrix} \\ &\times \begin{bmatrix} \tilde{R}_1 + \tilde{C}^T R_2 \tilde{C} + \frac{1}{2}(\tilde{P} \tilde{B} - \tilde{C}^T(I_m - \beta_0)R_0)R_0^{-1}(\tilde{B}^T \tilde{P} - R_0(I_m - \beta_0)\tilde{C}) & \tilde{P} \tilde{B} - \tilde{C}^T(I_m - \beta_0)R_0 \\ \tilde{B}^T \tilde{P} - R_0(I_m - \beta_0)\tilde{C} & 2R_0 \end{bmatrix} \\ &\times \begin{bmatrix} \tilde{x}(t) \\ \phi(u(t)) \end{bmatrix} - 2u^T(t)(\beta(u(t)) - \beta_0)R_0(I_m - \beta(u(t)))u(t) \\ &= - \frac{1}{2}[(\tilde{B}^T \tilde{P} - R_0(I_m - \beta_0)\tilde{C})\tilde{x}(t) + 2R_0\phi(u(t))]^T R_0^{-1}[(\tilde{B}^T \tilde{P} - R_0(I_m - \beta_0)\tilde{C})\tilde{x}(t) + 2R_0\phi(u(t))] \\ &\quad - \tilde{x}^T(t)\tilde{R}_1\tilde{x}(t) - u^T(t)[2(\beta(u(t)) - \beta_0)R_0(I_m - \beta(u(t))) + R_2]u(t) \quad (A 1) \end{aligned}$$

To guarantee that  $\dot{V}(\tilde{x}(t)) \leq 0$ , we need to show that  $2(\beta(u(t)) - \beta_0) \times R_0(I_m - \beta(u(t))) + R_2$  is positive definite for all  $t \geq 0$ . Since  $\beta(u(t)), \beta_0, R_0$  are diagonal matrices, the proof is equivalent to proving that  $\beta(u(t)) \geq \beta_l I_m$ . To do this, note that for all  $t \in [0, \infty)$  it follows that

$$\begin{aligned} 2(\beta(u(t)) - \beta_0)R_0(I_m - \beta(u(t))) + R_2 &= 2R_0^{1/2}[(\beta(u(t)) - \beta_0)(I_m - \beta(u(t))) + \frac{1}{2}R_0^{-1/2}R_2R_0^{-1/2}]R_0^{1/2} \\ &= 2R_0^{1/2}[(-\beta^2(u(t)) + \beta(u(t)) + \beta(u(t))\beta_0 - \beta_0 + \frac{1}{2}\lambda_{\min}(R_0^{-1/2}R_2R_0^{-1/2}))I_m \\ &\quad + \frac{1}{2}R_0^{-1/2}R_2R_0^{-1/2} - \frac{1}{2}\lambda_{\min}(R_0^{-1/2}R_2R_0^{-1/2})I_m]R_0^{1/2} \end{aligned}$$

If  $\beta_{0\max} \leq \frac{1}{2}\lambda_{\min}(R_0^{-1/2}R_2R_0^{-1/2}) = \frac{1}{2}\lambda_{\min}(R_2R_0^{-1})$ , which is equivalent to  $\beta_l = 0$ , it is easy to check that  $2(\beta(u(t)) - \beta_0)(1 - \beta(u(t)))R_0 + R_2 > 0$  for all  $t \in [0, \infty)$ . Thus,  $\dot{V}(\tilde{x}(t)) \leq 0$  for all  $t \in [0, \infty)$ . If  $\dot{V}(\tilde{x}(t)) = 0$ , for all  $t \geq 0$ , it follows from (A 1) that  $u(t) = \tilde{C}\tilde{x}(t) = 0$ , which gives  $\tilde{x}(t) = \exp(\tilde{A}t)\tilde{x}_0$ , and thus  $\tilde{C}\tilde{x}(t) = \tilde{C}\exp(\tilde{A}t)\tilde{x}_0 = 0$ . Since  $(\tilde{A}, \tilde{C})$  is observable, the invariant set consists of  $\tilde{x} = 0$ . It thus follows that  $\dot{V}(\tilde{x}(t)) \rightarrow 0$  as  $t \rightarrow \infty$  and the closed-loop system (2.1), (2.2) is asymptotically stable.

On the other hand, suppose that  $\beta_{0\max} > \frac{1}{2}\lambda_{\min}(R_2R_0^{-1})$ . In this case  $(1 - \beta_{0\max})^2 + 2\lambda_{\min}(R_2R_0^{-1}) < (1 + \beta_{0\max})^2$  and thus  $\beta_l = \frac{1}{2}[1 + \beta_{0\max} - \{(1 - \beta_{0\max})^2 + 2\lambda_{\min}(R_2R_0^{-1})\}^{1/2}]$ . Furthermore, we have the identity



$$\begin{aligned}
& 2[\beta(u(t)) - \beta_0]R_0[I_m - \beta(u(t))] + R_2 \\
& = R_0^{1/2} \{2[\beta(u(t)) - \beta_1 I_m] \frac{1}{2} [1 + \beta_{0\max} + \{(1 - \beta_{0\max})^2 + 2\lambda_{\min}(R_2 R_0^{-1})\}^{1/2}] I_m - \beta(u(t))\} \\
& \quad + R_0^{-1/2} R_2 R_0^{-1/2} - \lambda_{\min}(R_0^{-1/2} R_2 R_0^{-1/2}) I_m \\
& \quad + 2(\beta_{0\max} I_m - \beta_0)(I_m - \beta(u(t))) \} R_0^{1/2} \tag{A 2}
\end{aligned}$$

Also note that for all  $\beta_{0\max} \in [0, 1]$  it is easy to check that

$$\frac{1}{2}[(1 + \beta_{0\max}) + \{(1 - \beta_{0\max})^2 + 2\lambda_{\min}(R_2 R_0^{-1})\}^{1/2}] > 1$$

For all  $t \in [0, \infty)$  our goal is to show that  $\beta(u(t)) > \beta_1 I_m$ , so that  $2(\beta(u(t)) - \beta_0)R_0(I_m - \beta(u(t))) + R_2 > 0$ , and  $V(\tilde{x}(t)) \leq 0$ . Let  $t = 0$  and  $\tilde{x}_0 \in \tilde{\mathcal{D}}$ . If  $u_i^2(0) > \bar{u}_i^2$ ,  $i = 1, \dots, m$ , then by (2.5) and (2.7)

$$\frac{1}{\beta_i^2(u_i(0))} = \frac{u_i^2(0)}{\bar{u}_i^2} = \frac{\tilde{x}_0^T \tilde{C}_i^T \tilde{C}_i \tilde{x}_0}{\bar{u}_i^2} \leq \tilde{x}_0^T \tilde{P} \tilde{x}_0 \frac{\tilde{C}_i^T \tilde{P}^{-1} \tilde{C}_i}{\bar{u}_i^2} < \frac{1}{\beta_i^2}$$

so that  $\beta_i(u_i(0)) > \beta_i$ ,  $i = 1, \dots, m$  and hence  $\dot{V}(\tilde{x}(0)) \leq 0$ . If, on the other hand,  $u_i^2(0) \leq \bar{u}_i^2$ ,  $i = 1, \dots, m$ , then  $\beta_i(u_i(0)) = 1$ . In this case we also have  $V(\tilde{x}(0)) \leq 0$ . Two cases, that is,  $V(\tilde{x}(0)) < 0$  and  $V(\tilde{x}(0)) = 0$ , will be treated separately.

First consider the case  $V(\tilde{x}(0)) < 0$ . Suppose on the contrary there exist  $T_1 > T > 0$  such that  $V(\tilde{x}(t)) < 0$  for all  $t \in [0, T)$ ,  $V(\tilde{x}(T)) = 0$ , and  $V(\tilde{x}(t)) > 0$ ,  $t \in (T, T_1]$ . Since  $V(\tilde{x}(t)) < 0$ ,  $t \in [0, T)$ , there exists  $T_2$  satisfying  $T < T_2 \leq T_1$  and sufficiently close to  $T$  such that  $\tilde{x}^T(t) \tilde{P} \tilde{x}(t) = V(\tilde{x}(t)) < V(\tilde{x}_0) = \tilde{x}_0^T \tilde{P} \tilde{x}_0$ ,  $t \in (0, T_2]$ , and thus

$$\frac{u_i^2(t)}{\bar{u}_i^2} \leq \tilde{x}^T(t) \tilde{P} \tilde{x}(t) \frac{\tilde{C}_i^T \tilde{P}^{-1} \tilde{C}_i}{\bar{u}_i^2} < \tilde{x}_0^T \tilde{P} \tilde{x}_0 \frac{\tilde{C}_i^T \tilde{P}^{-1} \tilde{C}_i}{\bar{u}_i^2} < \frac{1}{\beta_i^2}, \quad i = 1, \dots, m$$

$t \in [0, T_2]$ . Hence,  $\beta_i(u_i(t)) > \beta_i$ ,  $i = 1, \dots, m$ ,  $t \in [0, T_2]$ . Since, by assumption,  $V(\tilde{x}(t)) > 0$ ,  $t \in (T, T_1]$ , it follows from (A 1) and (A 2) that  $\beta_i(u_i(t)) < \beta_i$ ,  $i = 1, \dots, m$ ,  $t \in (T, T_1]$ . Therefore,  $\beta_i(u_i(T_2)) < \beta_i$ ,  $i = 1, \dots, m$ , which is a contradiction. As a result,  $V(\tilde{x}(t)) \leq 0$ , for all  $t \geq 0$ . Again, using the assumption that  $(\tilde{A}, \tilde{C})$  is observable, we conclude that the closed-loop system (2.1), (2.2) is asymptotically stable.

Next, consider the case  $V(\tilde{x}(0)) = 0$ . It follows from (A 1), (A 2) and  $\beta_i(u_i(0)) > \beta_i$ ,  $i = 1, \dots, m$ , that  $u(0) = 0$ , that is,  $u^T(0)u(0) = 0$ . Since, for  $t > 0$ , also by (A 1),  $V(\tilde{x}(t)) > 0$  implies that there exists  $i \in \{1, \dots, m\}$  such that  $\beta_i(u_i(t)) < 1$ , that is,  $u^T(t)u(t) > \bar{u}_i^2$ . For  $t$  sufficiently close to 0, if this is the case, it will violate the continuity of  $u(t)$ . It follows that there exists  $T_0 > 0$  sufficiently close to 0 such that  $V(\tilde{x}(t)) \leq 0$  for all  $t \in (0, T_0]$ . Using similar arguments as in the case  $V(\tilde{x}(0)) < 0$ , it can be shown that  $V(\tilde{x}(t)) \neq 0$  for all  $t \in (0, T_0]$ . Therefore,  $V(\tilde{x}(t)) < 0$  for all  $t \in (0, T_0]$ . In particular,  $V(\tilde{x}(T_0)) < 0$ . Hence we can proceed as in the previous case where  $V(\tilde{x}(0)) < 0$  with the time 0 replaced by  $T_0$ . It thus follows that  $V(\tilde{x}(t)) \rightarrow 0$  as  $t \rightarrow \infty$  and the closed-loop system (2.1), (2.2) is asymptotically stable.  $\square$

The following lemma will be used in the next theorem.

**Lemma A.1:** Let  $i \in \{1, \dots, m\}$ , assume that  $|u_{si}(t)| \leq \bar{u}_i$  for all  $t \geq 0$ , and let  $u_{rsi}(\cdot)$  satisfy (4.5), with  $|u_{rs0i}| \leq \bar{u}_i$ . Then  $|u_{rsi}(t)| \leq \bar{u}_i$  for all  $t \geq 0$ .

**Proof:** Define  $V(u_{rsi}(t)) = u_{rsi}^2(t)$  and note that

$$\dot{V}(u_{rsi}(t)) = 2u_{rsi}(t)\dot{u}_{rsi}(t) = 2u_{rsi}(t) \operatorname{sat}_{\tau_i}(K_i[u_{si}(t) - u_{rsi}(t)])$$

It follows that for all  $t \geq 0$

$$\dot{V}(u_{rsi}(t)) \begin{cases} = 0, & u_{rsi}(t) = 0 \text{ or } u_{si}(t) = u_{rsi}(t) \\ > 0, & 0 < u_{rsi}(t) < u_{si}(t) \text{ or } u_{si}(t) < u_{rsi}(t) < 0 \\ < 0, & \text{otherwise} \end{cases}$$

Hence, if  $V(u_{rs0i}) \leq \bar{u}_i^2$  and  $|u_{si}(t)| \leq \bar{u}_i$  for all  $t \geq 0$ , it is easy to check that  $V(u_{rsi}(t)) \leq \bar{u}_i^2$  or  $|u_{rsi}(t)| \leq \bar{u}_i$  for all  $t \geq 0$ .  $\square$

**Proof of Theorem 4.1:** First note that by using (4.6) and (4.7),  $\dot{V}(\tilde{x}(t))$  can be written as

$$\dot{V}(\tilde{x}(t)) = - \begin{bmatrix} \tilde{x}^T(t) & \phi^T(\tilde{u}(t)) \end{bmatrix} \begin{bmatrix} -\tilde{A}^T \tilde{P} - \tilde{P} \tilde{A} & \tilde{P} \tilde{B} \\ \tilde{B}^T \tilde{P} & 0 \end{bmatrix} \begin{bmatrix} \tilde{x}(t) \\ \phi(\tilde{u}(t)) \end{bmatrix}$$

where  $\phi(\tilde{u}) \triangleq \tilde{u} - \sigma(\tilde{u})$ . Recalling that  $\tilde{u}(t) = \tilde{C}\tilde{x}(t) - \tilde{D}\phi(\tilde{u}(t))$ , we have

$$\begin{aligned} 2[\tilde{u}^T(t)(I - \beta_0) - \phi^T(\tilde{u}(t))]R_0\phi(\tilde{u}(t)) \\ = \tilde{x}^T(t)\tilde{C}^T(I - \beta_0)R_0\phi(\tilde{u}(t)) + \phi^T(\tilde{u}(t))R_0(I - \beta_0)\tilde{C}\tilde{x}(t) \\ - \phi^T(\tilde{u}(t))[2R_0 + \tilde{D}^T(I - \beta_0)R_0 + R_0(I - \beta_0)\tilde{D}]\phi(\tilde{u}(t)) \end{aligned}$$

and

$$\begin{aligned} \tilde{x}^T(t)\tilde{C}^T R_2 \tilde{C}\tilde{x}(t) &= (\tilde{u}(t) + \tilde{D}\phi(\tilde{u}(t)))^T R_2 (\tilde{u}(t) + \tilde{D}\phi(\tilde{u}(t))) \\ &= \tilde{u}^T(t)[I + \tilde{D}(I - \beta(\tilde{u}(t)))]^T R_2 [I + \tilde{D}(I - \beta(\tilde{u}(t)))]\tilde{u}(t) \end{aligned}$$

Adding and subtracting  $2[\tilde{u}^T(t)(I - \beta_0) - \phi^T(\tilde{u}(t))]R_0\phi(\tilde{u}(t))$  and using (4.8) yields

$$\begin{aligned} \dot{V}(\tilde{x}(t)) \\ = - \begin{bmatrix} \tilde{x}^T(t) & \phi^T(\tilde{u}(t)) \end{bmatrix} \begin{bmatrix} -(\tilde{A}^T \tilde{P} + \tilde{P} \tilde{A}) & \tilde{P} \tilde{B} - \tilde{C}^T(I - \beta_0)R_0 \\ \tilde{B}^T \tilde{P} - R_0(I - \beta_0)\tilde{C} & 2R_0 + \tilde{D}^T(I - \beta_0)R_0 + R_0(I - \beta_0)\tilde{D} \end{bmatrix} \begin{bmatrix} \tilde{x}(t) \\ \phi(\tilde{u}(t)) \end{bmatrix} \\ - 2\tilde{u}^T(t)(\beta(\tilde{u}(t)) - \beta_0)R_0(I - \beta(\tilde{u}(t)))\tilde{u}(t) \\ = - \frac{1}{2}[(\tilde{B}^T \tilde{P} - R_0(I - \beta_0)\tilde{C})\tilde{x}(t) + 2\tilde{R}_0\phi(\tilde{u}(t))]^T \tilde{R}_0^{-1} [(\tilde{B}^T \tilde{P} - R_0(I - \beta_0)\tilde{C})\tilde{x}(t) + 2\tilde{R}_0\phi(\tilde{u}(t))] \\ - \tilde{x}^T(t)\tilde{R}_1\tilde{x}(t) - \tilde{x}^T(t)\tilde{C}^T R_2 \tilde{C}\tilde{x}(t) - 2\tilde{u}^T(t)(\beta(\tilde{u}(t)) - \beta_0)R_0(I - \beta(\tilde{u}(t)))\tilde{u}(t) \\ = - \frac{1}{2}[(\tilde{B}^T \tilde{P} - R_0(I - \beta_0)\tilde{C})\tilde{x}(t) + 2\tilde{R}_0\phi(\tilde{u}(t))]^T \tilde{R}_0^{-1} [(\tilde{B}^T \tilde{P} - R_0(I - \beta_0)\tilde{C})\tilde{x}(t) + 2\tilde{R}_0\phi(\tilde{u}(t))] \\ - \tilde{u}^T(t)\{2(\beta(\tilde{u}(t)) - \beta_0)R_0(I - \beta(\tilde{u}(t))) + [I + \tilde{D}(I - \beta(\tilde{u}(t)))]^T R_2 [I + \tilde{D}(I - \beta(\tilde{u}(t)))]\}\tilde{u}(t) \\ - \tilde{x}^T(t)\tilde{R}_1\tilde{x}(t) \end{aligned} \quad (\text{A } 3)$$

where  $\tilde{R}_0 \triangleq R_0 + \frac{1}{2}[\tilde{D}^T(I - \beta_0)R_0 + R_0(I - \beta_0)\tilde{D}]$ . To guarantee that  $\dot{V}(\tilde{x}(t)) \leq 0$ , we need to show that  $2(\beta(\tilde{u}(t)) - \beta_0)R_0(I - \beta(\tilde{u}(t))) + [I + \tilde{D}(I - \beta(\tilde{u}(t)))]^T R_2 [I + \tilde{D}(I - \beta(\tilde{u}(t)))]$  is positive definite for all  $t \geq 0$ . For convenience,  $\beta(\tilde{u}(t))$  is decomposed as

$$\beta(\tilde{u}(t)) = \begin{bmatrix} \beta_u(u(t)) & 0 \\ 0 & \beta_v(v(t)) \end{bmatrix}$$

then it follows that

$$2(\beta(\tilde{u}(t)) - \beta_0)R_0(I - \beta(\tilde{u}(t))) + [I + \tilde{D}(I - \beta(\tilde{u}(t)))]^T R_2 [I + \tilde{D}(I - \beta(\tilde{u}(t)))] \\ = \begin{bmatrix} 2(\beta_u(u(t)) - \beta_{0u})R_{0u}(I - \beta_u(u(t))) + R_{2u} & 0 \\ 0 & 2(\beta_v(v(t)) - \beta_{0v})R_{0v}(I - \beta_v(v(t))) \end{bmatrix} \\ + \begin{bmatrix} (I - \beta_u(u(t)))KR_{2v}K(I - \beta_u(u(t))) & (I - \beta_u(u(t)))KR_{2v} \\ R_{2v}K(I - \beta_u(u(t))) & R_{2v} \end{bmatrix}$$

Hence it is sufficient to have  $2(\beta_u(u(t)) - \beta_{0u})R_{0u}(I - \beta_u(u(t))) + R_{2u} > 0$  and  $\beta_v(v(t)) - \beta_{0v} \geq 0$  to ensure  $V(\tilde{x}(t)) \leq 0$  for all  $t \geq 0$ . It then follows the same procedure as in Tyan and Bernstein (1995 a), that if  $V(\tilde{x}_0) < V_0$ , then  $2(\beta_u(u(t)) - \beta_{0u})R_{0u}(I - \beta_u(u(t))) + R_{2u} > 0$ . It follows from Lemma A.1 that for  $i = 1, \dots, m$ , if  $|\sigma_{rsi}(u_i(0))| \leq \bar{u}_i$ , and  $|\sigma_{si}(u_i(0))| \leq \bar{u}_i$ , then  $|\sigma_{rsi}(u_i(t))| \leq \bar{u}_i$ , for all  $t \geq 0$ . As a result,  $|v_i(t)| \leq 2K_i\bar{u}_i$ , and  $\beta_{v_i}(v_i(t)) \geq \bar{v}_i/(2K_i\bar{u}_i)$ ,  $i = 1, \dots, m$ , for all  $t \geq 0$ . Therefore, if  $\beta_{0v_i} \in [0, \min\{1, \bar{v}_i/(2K_i\bar{u}_i)\}]$  then  $\beta_{v_i}(v_i(t)) \geq \beta_{0v_i}$ ,  $i = 1, \dots, m$ , for all  $t \geq 0$ . Hence  $V(\tilde{x}(t)) \leq 0$  for all  $t \geq 0$ .  $\square$

#### REFERENCES

- ANDERSON, B. D. O., 1967, A system theory criterion for positive real matrices. *SIAM Journal on Control and Optimization*, **5**, 171–182.
- CAMPO, P. J., and MORARI, M., 1990, Robust control of processes subject to saturation nonlinearities. *Computers and Chemical Engineering*, **14**, 343–358.
- BERNSTEIN, D. S., and HADDAD, W. M., 1989, LQG Control with an  $H_\infty$  performance bound: a Riccati equation approach. *IEEE Transactions on Automatic Control*, **34**, 293–305.
- FENG, G., PALANISWAMI, M., and ZHU, Y., 1992, Stability of rate constrained robust pole placement adaptive control systems. *Systems and Control Letters*, **18**, 99–107.
- FRANKENA, J. F., and SIVAN, R., 1979, A non-linear optimal control law for linear systems. *International Journal of Control*, **30**, 159–178.
- FULLER, A. T., 1969, In-the-large stability of relay and saturating control systems with linear controllers. *International Journal of Control*, **10**, 457–480.
- GE, Y., WATSON, L. T., COLLINS, E. G., and BERNSTEIN, D. S., 1994, Probability-one homotopy algorithms for full and reduced order  $H^2/H^\infty$  controller synthesis. *Proceedings of the IEEE Conference on Decision and Control*, Orlando, Florida, U.S.A., pp. 2672–2677.
- GREILEY, S. W., and HYLAND, D. C., 1988, Reduced-order compensation: linear-quadratic reduction versus optimal projection. *AIAA Journal of Guidance, Control and Dynamics*, **11**, 328–335.
- GUTMAN, P. O., and HAGANDER, P., 1985, A new design of constrained controllers for linear systems. *IEEE Transactions on Automatic Control*, **30**, 22–33.
- HADDAD, W., and BERNSTEIN, D. S., 1991, Robust stabilization with positive real uncertainty: beyond the small gain theorem. *Systems and Control Letters*, **17**, 191–208.
- HANSON, G. D., and STENGEL, R. F., 1984, Effects of displacement and rate saturation on the control of statically unstable aircraft. *AIAA Journal of Guidance, Control and Dynamics*, **7**, 197–205.
- HOROWITZ, I., 1983, A synthesis theory for a class of saturating systems. *International Journal of Control*, **38**, 169–187.
- HOROWITZ, I., 1984, Feedback systems with rate and amplitude limiting. *International Journal of Control*, **40**, 1215–1229.
- KAPASOURIS, P., and ATHANS, M., 1990, Control systems with rate and magnitude saturation for neutrally stable open loop systems. *Proceedings of the IEEE Conference on Decision and Control*, Honolulu, Hawaii, U.S.A., pp. 3404–3409.
- KLAI, M., TARBOURIECH, S., and BURGA, C., 1993, Stabilization via reduced-order observer for a class of saturated linear systems. *Proceedings of the IEEE Conference on Decision and Control*, San Antonio, Texas, U.S.A., pp. 1814–1819.

- KOSUT, R. L., 1983, Design of linear systems with saturating linear control and bounded states. *IEEE Transactions on Automatic Control*, **28**, 121–124.
- LEMAY, J. L., 1964, Recoverable and reachable zones for control systems with linear plants and bounded controller outputs. *IEEE Transactions on Automatic Control*, **9**, 346–354.
- LIN, Z., and SABERI, A., 1993, Semi-global exponential stabilization of linear systems subject to 'input saturation' via linear feedbacks. *Systems and Control Letters*, **21**, 225–239.
- LIN, Z., SABERI, A., and TEEL, A. R., 1995, Simultaneous  $L_p$ -stabilization and internal stabilization of linear systems subject to actuator saturation—state feedback case. *Systems and Control Letters*, **25**, 219–226.
- LINDNER, D. K., CELANO, T. P., and IDE, E. N., 1991, Vibration suppression using a proofmass actuator operating in stroke/force saturation. *Journal of Vibration and Acoustics*, **113**, 423–433.
- MATHWORKS INC, 1993, *SIMULINK User's Guide*, Natick, MA, 4-66–4-67.
- RODRIGUEZ, A. A., and CLOUTIER, J. R., 1994, Control of a bank-to-turn (BTT) missile with saturating actuators. *Proceedings of American Control Conference*, Baltimore, Maryland, U.S.A., pp. 1660–1664.
- RYAN, E. P., 1982, *Optimal Relay and Saturating Control System Synthesis* (London, U.K.: Peter Peregrinus).
- SHRIVASTAVA, P. C., and STENGEL, R. F., 1989, Stability boundaries for aircraft with unstable lateral-directional dynamics and control saturation. *AIAA Journal of Guidance, Control and Dynamics*, **12**, 62–70.
- SONTAG, E. D., 1984, An algebraic approach to bounded controllability of linear systems. *International Journal of Control*, **39**, 181–188.
- TEEL, A. R., 1995, Semi-global stabilizability of linear null controllable systems with input nonlinearities. *IEEE Transactions on Automatic Control*, **40**, 96–100.
- TYAN, F., and BERNSTEIN, D. S., 1995a, Antiwindup compensator synthesis for systems with saturating actuators. *International Journal of Robust and Nonlinear Control*, **5**, 521–538; 1995 b, Dynamic output feedback compensation for systems with input saturation. *Proceedings of American Control Conference*, Seattle, Washington, U.S.A., June, pp. 3916–3920.
- WREDENHAGEN, G. F., and BELANGER, P. R., 1994, Piecewise-linear LQ control for systems with input constraints. *Automatica*, **30**, 403–416.
- ZHANG, C., and EVANS, R. J., 1988, Rate constrained adaptive control. *International Journal of Control*, **48**, 2179–2187.